



INSTRUCTION MANUAL

VHF MARINE TRANSCEIVER

IC-GM651



FOREWORD

Thank you for purchasing this Icom transceiver. The IC-GM651 VHF MARINE TRANSCEIVER is designed and built with Icom's state of the art technology and craftsmanship. With proper care, this transceiver should provide you with years of trouble-free operation.

We want to take a couple of moments of your time to thank you for making the IC-GM651 your radio of choice, and hope you agree with Icom's philosophy of "technology first." Many hours of research and development went into the design of your IC-GM651.

◇ **FEATURES**

- *Built-in DSC meets ITU Class A requirement with PS-250 DC-DC POWER SUPPLY*
- *Rugged waterproof construction*
- *Large LCD with dot matrix characters*
- *Microphone (to front panel) and Handset (to rear panel) connections*

Icom, Icom Inc. and the ICOM logo are registered trademarks of Icom Incorporated (Japan) in the United States, the United Kingdom, Germany, France, Spain, Russia and/or other countries.

IBM is a registered trademark of International Business Machines.

IMPORTANT

READ ALL INSTRUCTIONS carefully and completely before using the transceiver.

SAVE THIS INSTRUCTION MANUAL — This instruction manual contains important operating instructions for the IC-GM651.

EXPLICIT DEFINITIONS

WORD	DEFINITION
⚠ WARNING	Personal injury, fire hazard or electric shock may occur.
CAUTION	Equipment damage may occur.
NOTE	If disregarded, inconvenience only. No risk of personal injury, fire or electric shock.

CLEAN THE TRANSCEIVER AND MICROPHONE THOROUGHLY WITH FRESH WATER after exposure to water including salt, otherwise, the keys and switch may become inoperable due to salt crystallization.

PRECAUTIONS

⚠ WARNING! NEVER connect the transceiver to an AC outlet. This may pose a fire hazard or result in an electric shock.

NEVER connect the transceiver to an external DC power supply directly. The transceiver should be connected to the DC power supply through the PS-250 (input voltage: 10.8 to 31.2 V DC) that is sold by the set with this transceiver. Be sure to not connect with reverse polarity.

NEVER cut the DC power cable between the DC plug and fuse holder. If an incorrect connection is made after cutting, the transceiver may be damaged.

NEVER place the transceiver where normal operation of the vessel may be hindered or where it could cause bodily injury.

KEEP the transceiver at least 1 m away from the ship's navigation compass.

DO NOT use or place the transceiver in areas with temperatures below -15°C or above $+55^{\circ}\text{C}$ or, in areas subject to direct sunlight, such as the dashboard.

DO NOT use the chemical agents such as benzine or alcohol when cleaning, as they may damage the transceiver surfaces. If the transceiver becomes dusty or dirty, wipe it clean with a soft, dry cloth.

BE CAREFUL! The transceiver rear panel will become hot when operating continuously for long periods. Place the transceiver in a secure place to avoid inadvertent use by children.

BE CAREFUL! The transceiver employs waterproof construction, which correspond to IPX7 of the international standard IEC 60529 (2001). However, once the transceiver have been dropped, waterproofing cannot be guaranteed due to the fact that the case may be cracked, or the waterproof seal damaged, etc.

Icom optional equipment is designed for optimal performance when used with this transceiver. We are not responsible for the transceiver being damaged or any accident caused when using non-Icom optional equipment.

IN CASE OF EMERGENCY

If your vessel requires assistance, contact other vessels and the Coast Guard by sending a Distress call on Channel 16.

USING CHANNEL 16

DISTRESS CALL PROCEDURE

1. "MAYDAY MAYDAY MAYDAY."
2. "THIS IS" (name of vessel).
3. Say your call sign or other indication of the vessel (AND 9-digit DSC ID if you have one).
4. "LOCATED AT" (your position).
5. State the nature of the distress and assistance required.
6. Give any other information which might facilitate the rescue.

Or, transmit your Distress call using digital selective calling on Channel 70.

USING DIGITAL SELECTIVE CALLING (Ch 70)

DISTRESS CALL PROCEDURE

1. While lifting up the key cover, push and hold **[DISTRESS]** for 3 sec. until you hear 3 short beeps change to one long beep.
2. Wait for an acknowledgment on Channel 70 from a coast station.
 - After the acknowledgement is received, Channel 16 is automatically selected.
3. Push and hold **[PTT]**, then transmit the appropriate information as listed above.

INSTALLATION NOTE

The installation of this equipment should be made in such a manner as to respect the EC recommended electromagnetic field exposure limits (1999/519/EC).

The maximum RF power available from this device is 25 watts. The antenna should be installed as high as possible for maximum efficiency and that this installation height should be at least 5 meters above ground (or accessible) level. In the case where an antenna cannot be installed at a reasonable height, then the transmitter should neither be continuously operated for long periods if any person is within 5 meters of the antenna, nor operated at all if any person is touching the antenna.

In all cases any possible risk depends on the transmitter being activated for long periods. (actual recommendation limits are specified as an average of 6 minutes) Normally the transmitter is not active for long periods of time. Some radio licenses will require that a timer circuit automatically cuts the transmitter after 1–2 minutes etc.

Similarly some types of transmitter, SSB, CW, AM, etc. have a lower 'average' output power and the perceived risk is even lower.

FIRMWARE VERSION NUMBER

The firmware version number is displayed in the opening screen as below.

The version number is also displayed when MMSI code check screen is selected. (see p. 18)

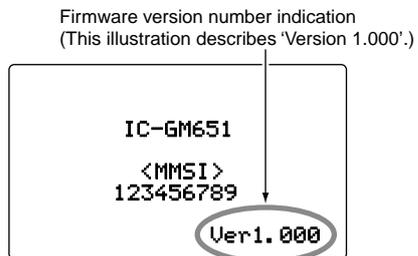

TABLE OF CONTENTS

FOREWORD	i
IMPORTANT	i
EXPLICIT DEFINITIONS	i
PRECAUTIONS	ii
IN CASE OF EMERGENCY	iii
INSTALLATION NOTE	iii
FIRMWARE VERSION NUMBER	iv
TABLE OF CONTENTS	v

1 OPERATING RULES	1
◇ PRIORITIES	1
◇ PRIVACY	1
◇ RADIO LICENSES	1

2 PANEL DESCRIPTION	2-6
■ Panel description	2
■ Function display	5

3 BASIC OPERATION	7-13
■ Channel selection	7
◇ Channel 16	7
◇ Call channel	7
◇ International channels (Depends on version)	8
■ Receiving and transmitting	8
■ Call channel programming	10
■ Channel comments	11
■ Microphone lock function	12
■ Printer function	12
■ Backlight function	13
■ AquaQuake water draining function	13

4 DUALWATCH/TRI-WATCH	14
■ Description	14
■ Operation	14

5 SCAN OPERATION	15-17
■ Scan types	15
■ Setting TAG channels	16
■ Starting a scan	16

6 DSC OPERATION	18-105
■ MMSI code programming	18
■ DSC address ID	19
◇ Programming Individual ID	19
◇ Deleting Individual ID	22
◇ Programming Group ID	23
◇ Deleting Group ID	26
■ Position and Time programming	27
■ Position and Time indication	30
■ GPS information indication	31
■ Distress call	32
◇ Simple call	32
◇ Regular call	34
◇ Transmitting a Distress Cancel	38
◇ Transmitting a Distress Acknowledgement call	39
◇ Transmitting a Distress Relay call	41
◇ Transmitting a Distress Relay Acknowledgement call	48

■ Transmitting DSC calls.....	50	■ Received messages	92
◇ Transmitting an All Ships call	50	◇ Distress message	92
◇ Transmitting an Individual call	52	◇ Other messages	95
◇ Transmitting an Individual Acknowledgement call.....	54	■ DSC Set mode.....	99
◇ Transmitting a Group call	60	◇ Printing out the DSC memory contents	99
◇ Transmitting a Position Request call	62	◇ Position Automatic Acknowledgement.....	100
◇ Transmitting a Position Reply call	64	◇ DSC Data Output.....	101
◇ Transmitting a Polling Reply call	67	◇ Squelch Level Setting for Channel 70 Receiver.....	102
◇ Transmitting a Medical Transports call	69	◇ Medical Transports item Appearance in DSC Set up menu ...	103
◇ Transmitting a Neutral Ship call	70	◇ Neutral Ship Call item Appearance in DSC Set up menu ...	104
◇ Transmitting a Test call.....	72	◇ Self Check Testing	105
◇ Transmitting a Test Acknowledgement call.....	74	7 SET MODE.....	106–108
■ Receiving DSC calls	75	■ Set mode programming	106
◇ Receiving a Distress call.....	75	■ Set mode items.....	107
◇ Receiving a Distress Acknowledgement call	77	◇ Scan type.....	107
◇ Receiving a Distress Cancel.....	78	◇ Scan resume timer.....	107
◇ Receiving a Distress Relay call	79	◇ Beep tone	107
◇ Receiving a Distress Relay Acknowledgement call	80	◇ Internal speaker	107
◇ Receiving an All Ships call.....	81	◇ Display contrast	108
◇ Receiving an Individual call	82	◇ Microphone type	108
◇ Receiving an Individual Acknowledgement call	83	◇ Cursor ↓ (Downward) movement	108
◇ Receiving a Group call.....	86		
◇ Receiving a Position Request call.....	87		
◇ Receiving a Position Reply call.....	88		
◇ Receiving a Polling Request call.....	89		
◇ Receiving a Test call	90		
◇ Receiving a Test Acknowledgement call	91		

TABLE OF CONTENTS (Continued)

8 CONNECTIONS AND MAINTENANCE.....	109–117
■ Connections.....	109
■ Antenna	110
■ Fuse replacement.....	110
■ Supplied accessories.....	111
◇ Accessory connectors set up.....	111
■ Power supply connections	112
◇ Connecting to the DC power supply through the PS-250...	112
◇ Connecting to the AC outlet through the PS-250 and optional PS-240	113
■ Mounting the transceiver	114
◇ Using the supplied mounting bracket.....	114
■ MB-75 installation	115
■ Microphone (HM-126RB).....	116
◇ Connection.....	116
■ Handset (HS-98).....	117
◇ Connection.....	117
9 TROUBLESHOOTING	118
10 SPECIFICATIONS AND OPTIONS.....	119–120
■ Specifications.....	119
◇ General	119
◇ Transmitter	119
◇ Receiver.....	119
◇ Dimensions.....	120
■ Options	120
11 CHANNEL LIST	121

◇ PRIORITIES

- Read all rules and regulations pertaining to priorities and keep an up-to-date copy handy. Safety and Distress calls take priority over all others.
- You must monitor Channel 16 when you are not operating on another channel.
- False or fraudulent distress signals are prohibited and punishable by law.

◇ PRIVACY

- Information overheard but not intended for you cannot lawfully be used in any way.
- Indecent or profane language is prohibited.

◇ RADIO LICENSES

(1) SHIP STATION LICENSE

You must have a current radio station license before using the transceiver. It is unlawful to operate a ship station which is not licensed.

Inquire through your dealer or the appropriate government agency for a Ship-Radiotelephone license application. This government-issued license states the call sign which is your craft's identification for radio purposes.

(2) OPERATOR'S LICENSE

A Restricted Radiotelephone Operator Permit is the license most often held by small vessel radio operators when a radio is not required for safety purposes.

The Restricted Radiotelephone Operator Permit must be posted or kept with the operator. Only a licensed radio operator may operate a transceiver.

However, non-licensed individuals may talk over a transceiver if a licensed operator starts, supervises, ends the call and makes the necessary log entries.

Keep a copy of the current government rules and regulations handy.

■ Panel description

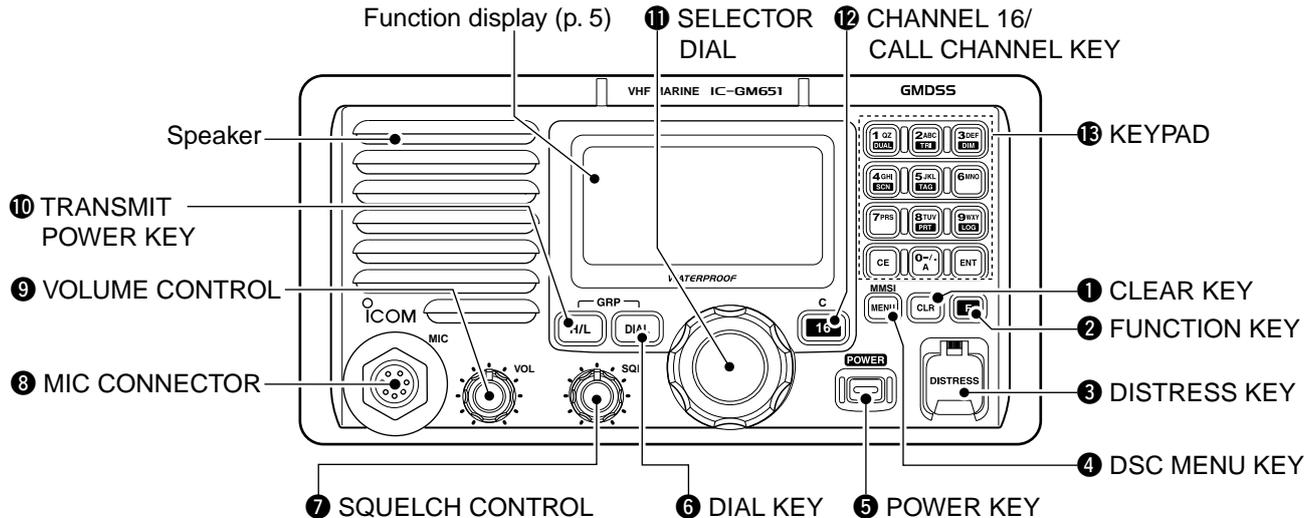

1 CLEAR KEY [CLR]

Push to cancel the entered function, stop the scan, exit Set mode, etc. (pgs. 14, 16, 106)

2 FUNCTION KEY [F]

After pushing this key, some keys perform secondary function.

- "F" appears when a secondary function can be accessed.

3 DISTRESS KEY [DISTRESS] (pgs. 32, 36)

Push and hold for 3 sec. to transmit a Distress call.

4 DSC MENU KEY [MENU•MMSI]

- ➔ Push to toggle the DSC menu ON or OFF.
- ➔ Push to enter the MMSI code programming condition when no MMSI code is programmed. (p. 18)
- ➔ Push and hold for 1 sec. to indicate the 9-digit MMSI code and firmware version number.

5 POWER KEY [POWER] (p. 8)

- ➔ Push to turn power ON and OFF.
 - The transceiver does not turn power ON when the connected PC-250 DC-DC POWER SUPPLY is turned OFF.
 - After turning power ON, the 9-digit MMSI code appears for 2 sec., if programmed.
 - When no MMSI code is programmed, "NO MMSI" is displayed at power ON, and then the MMSI code programming is required.
- ➔ While pushing and holding **[H/L]**, turn power ON to activate the AquaQuake function. (p. 13)
- ➔ While pushing and holding **[16•C]**, turn power ON to enter Set mode. (p. 106)

6 DIAL KEY [DIAL]

- ➔ Push to select to the regular channel. (pgs. 7, 8)
- ➔ While pushing and holding **[H/L]**, push to select one of three channel groups in sequence depending on version. (p. 8)
 - EUR version has International channels only and this function is not available.

7 SQUELCH CONTROL [SQL] (p. 8)

Rotate to set the squelch threshold level.

8 MIC CONNECTOR

Connect the optional hand microphone only. (p. 116)

CAUTION: NEVER connect the optional handset (HS-98) here.

9 VOLUME CONTROL [VOL] (p. 8)

Rotate to adjust the audio level.

10 TRANSMIT POWER KEY [H/L]

- ➔ Push to toggle the output power high or low. (p. 8)
 - Some channels are set to low power only.
- ➔ While pushing and holding this key, some keys perform secondary functions.

11 SELECTOR DIAL [SELECTOR] (pgs. 7, 8, 106)

Rotate to select the operating channels, set mode contents, etc.

12 CHANNEL 16/CALL CHANNEL KEY [16•C]

- ➔ Push to select Channel 16. (p. 7)
- ➔ Push and hold for 1 sec. to select call channel. (p. 7)
 - "CALL" appears when call channel is selected.
- ➔ Push and hold for 3 sec. to enter call channel programming condition when call channel is selected. (p. 10)

13 KEYPAD

- ➔ Inputs numeral for channel number input, etc.
 - After inputting the desired channel number, push **[ENT]**.
 - Push and hold **[0•A]** to input 'A' for simplex channels.
- ➔ Inputs numeral, alphabet and some symbols for channel comment input.
- ➔ After pushing **[F]**, push to perform the secondary function.
 - Most of secondary function (except TAG channel setting; p. 16, print out operation; p. 12) can be cleared or cancelled when **[CLR]** is pushed.

2 PANEL DESCRIPTION

1 QZ
DUAL

- ➔ Number input: '1'
- ➔ Comment input: 'Q,' 'Z,' 'q,' 'z' or space
- ➔ After pushing **[F]**, push to turn the Dualwatch function ON or OFF. (p. 14)

2 ABC
TRI

- ➔ Number input: '2'
- ➔ Comment input: 'A,' 'B,' 'C,' 'a,' 'b' or 'c'
- ➔ After pushing **[F]**, push to turn the Tri-watch function ON or OFF. (p. 14)

3 DEF
DIM

- ➔ Number input: '3'
- ➔ Comment input: 'D,' 'E,' 'F,' 'd,' 'e' or 'f'
- ➔ After pushing **[F]**, push this key then rotate **[SELECTOR]** to adjust the brightness of the LCD and key backlight. (p. 13)

4 GHI
SCN

- ➔ Number input: '4'
- ➔ Comment input: 'G,' 'H,' 'I,' 'g,' 'h' or 'i'
- ➔ After pushing **[F]**, push to start or stop the scan function. (p. 16)

5 JKL
TAG

- ➔ Number input: '5'
- ➔ Comment input: 'J,' 'K,' 'L,' 'j,' 'k' or 'l'
- ➔ After pushing **[F]**, push to set the displayed channel as a TAG channel. (p. 16)
- ➔ While pushing and holding **[H/L]**, push for 3 sec. to clear or set all TAG channels. (p. 16)

6 MNO

- ➔ Number input: '6'
- ➔ Comment input: 'M,' 'N,' 'O,' 'm,' 'n' or 'o'

7 PRS

- ➔ Number input: '7'
- ➔ Comment input: 'P,' 'R,' 'S,' 'p,' 'r' or 's'

8 TUV
PRT

- ➔ Number input: '8'
- ➔ Comment input: 'T,' 'U,' 'V,' 't,' 'u' or 'v'
- ➔ After pushing **[F]**, push to transfer the received DSC data to the printer. (p. 12)

9 WXY
LOG

- ➔ Number input: '9'
- ➔ Comment input: 'W,' 'X,' 'Y,' 'w,' 'x' or 'y'
- ➔ After pushing **[F]**, push to indicate the received message log. (pgs. 92, 95)

0 -/.
A

- ➔ Number input: '0'
- ➔ Number input: Push and hold for 1 sec. to input 'A' for simplex channel.
- ➔ Comment input: '0' and symbols ('-'/'/' ':')

ENT

- ➔ Push to enter the input channel comment, selected item, etc.

CE

- ➔ Push to clear the entered data.

■ Function display

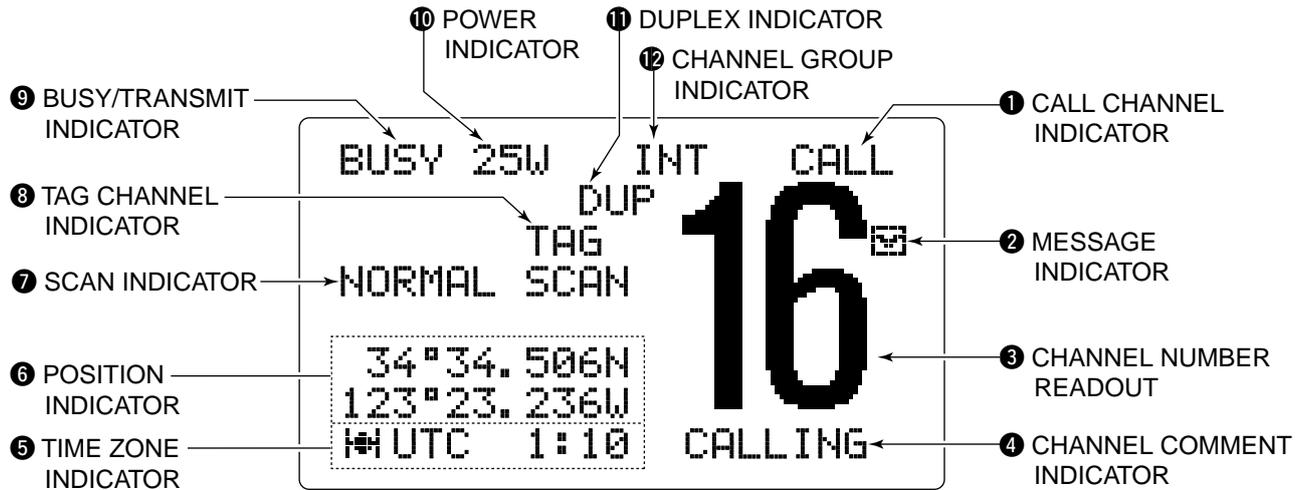

1 CALL CHANNEL INDICATOR (pgs. 7, 10)
Appears when the call channel is selected.

2 MESSAGE INDICATOR (pgs. 33, 75, 92)
Blinks when the unread message is stored in the Call Log memory.

3 CHANNEL NUMBER READOUT
Indicates the selected operating channel number.

4 CHANNEL COMMENT INDICATOR
Channel comment appears if programmed. (p. 11)

2 PANEL DESCRIPTION

5 TIME ZONE INDICATOR

- Shows the current time data when a GPS receiver is connected.
 - “??” and the last received time data may blink alternately every 2 sec. instead of current time data when the GPS current time data is invalid.
 - “??” and the last received time data may blink alternately every 2 sec. instead of current time data 4 hours after the time data is input manually, up until 23.5 hours have past.
- “No Time” appears when no GPS receiver is connected and no time data is input manually.
- “

6 POSITION INDICATOR

- Shows the GPS position data.
 - “??” and the last received position data may blink alternately every 2 sec. instead of position data when the GPS position data is invalid. In such a case, the last position data is held for up to 23.5 hours.
 - “??” and the last received position data may blink alternately every 2 sec. instead of position data 4 hours after the position data is input manually, up until 23.5 hours have past.
- “No Position” appears when no GPS receiver is connected and no position data is input manually.

7 SCAN INDICATOR

- “PRI-SCAN 16” appears during Priority scan; “NORMAL SCAN” appears during Normal scan. (p. 16)
- “DUAL 16” appears during Dualwatch; “TRI 16” appears during Tri-watch. (p. 14)

8 TAG CHANNEL INDICATOR (p. 16)

Appears when a TAG channel is selected.

9 BUSY/TRANSMIT INDICATOR

- “BUSY” appears when receiving a signal or when the squelch opens. (p. 8)
- “TX” appears while transmitting. (p. 9)

10 POWER INDICATOR (p. 8)

- “25W” appears when high power is selected.
- “1W” appears when low power is selected.

11 DUPLEX INDICATOR (p. 8)

Appears when a duplex channel is selected.

12 CHANNEL GROUP INDICATOR (p. 8)

Indicates when an International “INT” channel is in use. (Depends on version)

■ Channel selection

◇ Channel 16

Channel 16 is the distress and safety channel. It is used for establishing initial contact with a station and for emergency communications. Channel 16 is monitored during both Du-alwatch and Tri-watch. While standing by, you must monitor Channel 16.

- ① Push **[16•C]** momentarily to select Channel 16.

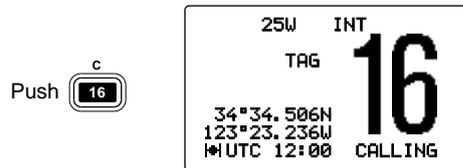

- ② Push **[DIAL]** to return to the condition before selecting Channel 16, or rotate **[SELECTOR]** to select a channel.
 - Pushing the keypad or **[▲]/[▼]** on the microphone also selects a channel.

◇ Call channel

Each regular channel group has a separate leisure-use call channel. The call channel is monitored during Tri-watch. The call channels can be programmed (p. 10) and are used to store your most often used channel in each channel group for quick recall.

- ① Push and hold **[16•C]** for 1 sec. to select the call channel of the selected channel group.
 - “CALL” and call channel number appear.
 - Each channel group may have an independent call channel after programming a call channel. (p. 10)

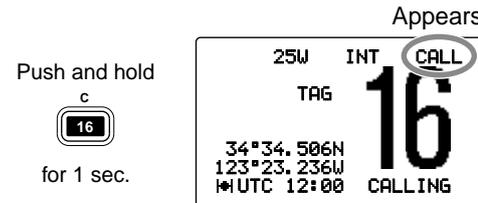

- ② Push **[DIAL]** to return to the condition before selecting call channel, or rotate **[SELECTOR]** to select a channel.
 - Pushing the keypad or **[▲]/[▼]** on the microphone also selects a channel.

3 BASIC OPERATION

◆ International channels (Depends on version)

There are pre-programmed 57 international channels for the IC-GM651.

- ① Push **[DIAL]** to select a regular channel.
- ② While pushing and holding **[H/L]**, push **[DIAL]** to change the channel group, if necessary.
 - “INT” appears when International channel is selected.

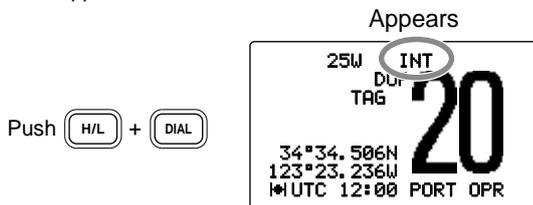

- ③ Rotate **[SELECTOR]** to select a channel.
 - “DUP” appears for duplex channels.
 - Pushing the keypad or **[▲]/[▼]** on the microphone also selects a channel.

■ Receiving and transmitting

CAUTION: Transmitting without an antenna will damage the transceiver.

- ① Push **[POWER]** to turn power ON.
 - After turning power ON, the 9-digit MMSI code appears for 2 sec. (If no MMSI code is programmed, “NO MMSI” appears and the MMSI programming is required; p. 18)
 - The transceiver does not turn power ON when the connected PC-250 DC-DC POWER SUPPLY is turned OFF.
- ② Set the audio and squelch levels.
 - ➔ Rotate **[SQL]** fully counterclockwise in advance.
 - ➔ Rotate **[VOL]** to adjust the audio output level.
 - ➔ Rotate **[SQL]** clockwise until the noise disappears.
- ③ While pushing and holding **[H/L]**, push **[DIAL]** several times to change the channel group. (p. 8)
- ④ Rotate **[SELECTOR]** to select a channel. (pgs. 7, 8, 121)
 - Pushing the keypad or **[▲]/[▼]** on the microphone also selects a channel.
 - When receiving a signal, “BUSY” appears and audio is emitted from the speaker.
 - Further adjustment of **[VOL]** may be necessary.
- ⑤ Push **[H/L]** to select the output power if necessary.
 - “25W” or “1W” appears when high or low power is selected, respectively.
 - Choose low power for short range communications, choose high power for longer distance communications.
 - Some channels are for low power only.

- ⑥ Push and hold **[PTT]** to transmit, then speak into the microphone.
 - “TX” appears.
 - Channel 70 cannot be used for transmission other than DSC.
- ⑦ Release **[PTT]** to receive.

IMPORTANT: To maximize the readability of your transmitted signal, pause a few sec. after pushing **[PTT]**, hold the microphone 5 to 10 cm from your mouth and speak at a normal voice level.

NOTE for TOT (Time-out Timer) function
 The TOT function inhibits continuous transmission over 5 minutes after the transmission starts. A short beep sounds 10 seconds before the TOT function is activated, and “TOT” blinks in the channel comment indicator. When the TOT is activated, error beeps sound at normal volume while **[PTT]** is pushed.

- Transmission is not possible and “TIME OUT” appears in the channel comment indicator for 10 sec. after this transmission shut down.

When the optional HS-98 is used, the receiving audio is emitted from the connected external speaker, or muted depending on the speaker switch condition. See p. 117 for details.

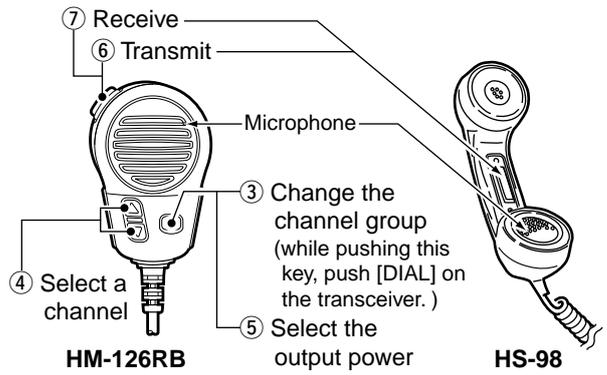
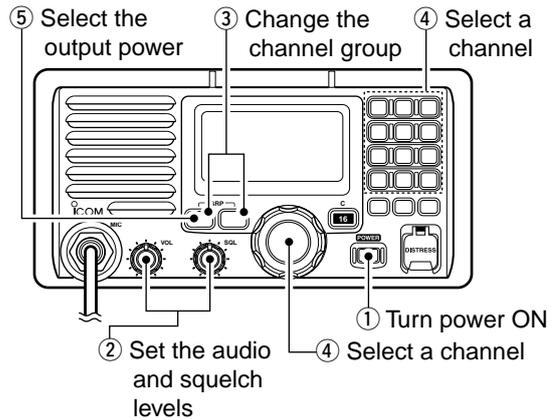

3 BASIC OPERATION

■ Call channel programming

You can program the call channel with your most often-used channels in each channel group for quick recall.

- ① While pushing and holding [H/L], push [DIAL] several times to select the desired channel group to be programmed.

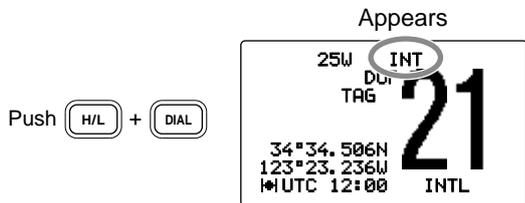

- ② Push and hold [16•C] for 1 sec. to select the call channel of the selected channel group.
 - “CALL” and call channel number appear.

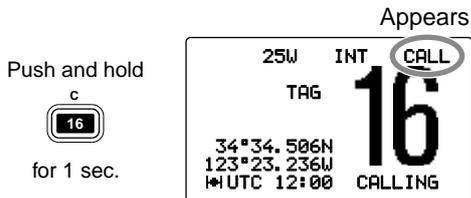

- ③ Push and hold [16•C] again for 3 sec. (until a long beep changes to 2 short beeps) to enter call channel programming condition.
 - Channel number starts blinking.

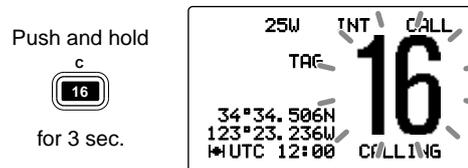

- ④ Rotate [SELECTOR] to select the desired channel.

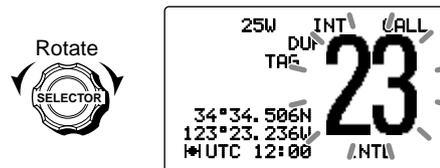

- ⑤ Push [16•C] to program the displayed channel as the call channel.
 - Push [CLR] to cancel.
 - The channel number stops blinking.

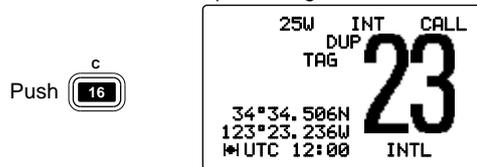

3 BASIC OPERATION

④ Push [ENT] to input and set the comment.

- The cursor and the character stop blinking.

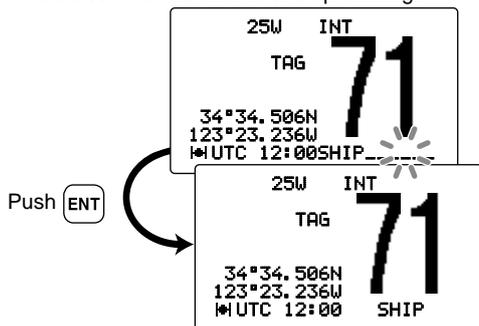

⑤ Repeat steps ① to ④ to program other channel comments, if desired.

• Available characters

KEY	CHARACTERS	KEY	CHARACTERS
1 QZ DUAL	1 Q Z q z (space)	6 MNO	6 M N O m n o
2 ABC TRI	2 A B C a b c	7 PRS	7 P R S P r s
3 DEF DIM	3 D E F d e f	8 TUV PRT	8 T U V t u v
4 GHI SCN	4 G H I g h i	9 WXY LOG	9 W X Y w x y
5 JKL TAG	5 J K L j k l	0 - / . A	0 - / .

■ Microphone lock function

The microphone lock function electrically locks [▲]/[▼] and [HI/LO] keys on the optional microphone. This prevents accidental channel changes and function access.

- ➔ While pushing and holding [HI/LO] on the microphone, turn power ON to toggle the microphone lock function ON and OFF.



■ Printer function

The received DSC call contents can be printed out when a printer (IBM® centronics or compatible) is connected to the transceiver.

- ➔ After pushing [F], push [8•PRT] to transfer the received DSC call data or Address ID to the printer.

NOTE: The degree sign is converted to the period as below when the DSC call data, included the position data, is printed out.

The display contents The printout contents
 LAT:-12°3.111N → LAT:-12.23.111N

■ Backlight function

This function lights the function display and keys, and it is convenient for a nighttime operation. The backlight brightness can be adjusted as follows.

- After pushing **[E]**, push **[3•DIM]** then rotate **[SELECTOR]** to adjust the brightness of the display and key backlight. Then push **[ENT]**.
 - The backlight is adjustable in 7 levels and OFF.

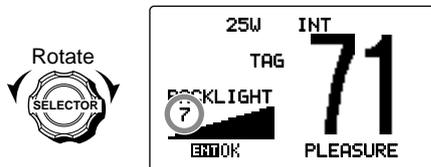

✓ For DSC operation

When the backlight blinks during DSC operation (receiving a call, **[DISTRESS]** is pushed and held, etc.), the backlight level 7 (Max.) and OFF (Min.) are repeated alternately regardless of above setting.

After the blinking stops, the backlight selects level “4” if the backlight level has been set to OFF or 1 to 3.

- If the backlight level is set to 4 to 7, the setting level holds after the blinking stops.

■ AquaQuake water draining function

The AquaQuake water draining function clears water away from the speaker grill. Without this function, water may muffle the sound coming from the speaker.

The IC-GM651 emits a low beep tone when this function is activated.

- While pushing and holding **[H/L]**, turn power ON to activate the AquaQuake function.
 - You should continue to push and hold **[H/L]** to drain water away from the speaker grill after turning power ON.
 - “Aqua Quake” is displayed on the LCD when the AquaQuake function activates.
 - A low beep tone sounds while **[H/L]** is pushed and held to drain water, regardless of **[VOL]** control setting.
 - The transceiver never accepts a key operation while the AquaQuake function is activated.
 - After releasing **[H/L]**, the transceiver returns to the normal operation condition.

▨ The AquaQuake function should be activated for about 5 sec. to sufficiently clear water away from the speaker grill.

■ Description

Dualwatch monitors Channel 16 while you are receiving on another channel; Tri-watch monitors Channel 16 and the call channel while receiving another channel. Dualwatch/Tri-watch is convenient for monitoring Channel 16 when you are operating on another channel.

DUALWATCH/TRI-WATCH SIMULATION

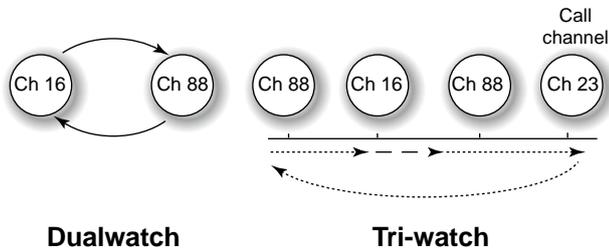

- If a signal is received on Channel 16, Dualwatch/Tri-watch pauses on Channel 16 until the signal disappears.
- If a signal is received on the call channel during Tri-watch, Tri-watch becomes Dualwatch until the signal disappears.
- To transmit on the selected channel during Dualwatch/Tri-watch, push and hold [PTT]. (Depends on the pre-setting.)

■ Operation

- ① Select the desired channel.
- ② Push [F], then push [1•DUAL] to start Dualwatch or [2•TRI] to start Tri-watch.
 - "DUAL 16" appears during Dualwatch; "TRI 16" appears during Tri-watch.
 - A beep tone sounds when a signal is received on Channel 16.
- ③ To cancel Dualwatch or Tri-watch, push [CLR] or repeat step ②.

[Example]: Operating Tri-watch on INT Channel 25

Tri-watch starts.

```

25W  INT
   TAG DUP
   TRI 16
34°34.506N
123°23.236W
UTC 12:00 TELEPHONE
  
```

Signal is received on call channel.

```

BUSY 25W  INT CALL
   TAG DUP
   TRI 16
34°34.506N
123°23.236W
UTC 12:00 INTL
  
```

Tri-watch resumes after the signal disappears.

```

25W  INT
   TAG DUP
   TRI 16
34°34.506N
123°23.236W
UTC 12:00 TELEPHONE
  
```

Signal received on Channel 16 takes priority.

```

BUSY 25W  INT
   TAG DUP
   TRI 16
34°34.506N
123°23.236W
UTC 12:00 TELEPHONE
  
```

■ Scan types

Scanning is an efficient way to locate signals quickly over a wide frequency range. The transceiver has Priority scan and Normal scan.

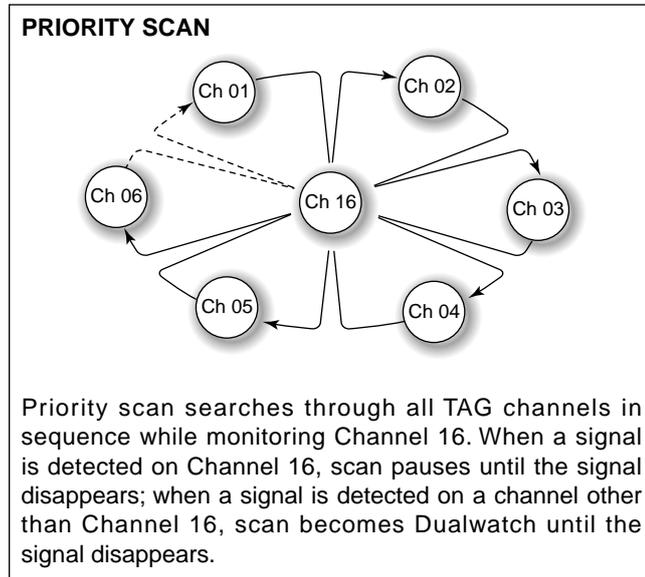

Set the TAG channels (scanned channel) before scanning. Clear the TAG for unwanted channels which inconveniently stop scanning, such as those for digital communication use. (Refer to the next page for details.)

/// Choose the desired scan type from 'Priority' or 'Normal' in
/// Set mode. (p. 107)

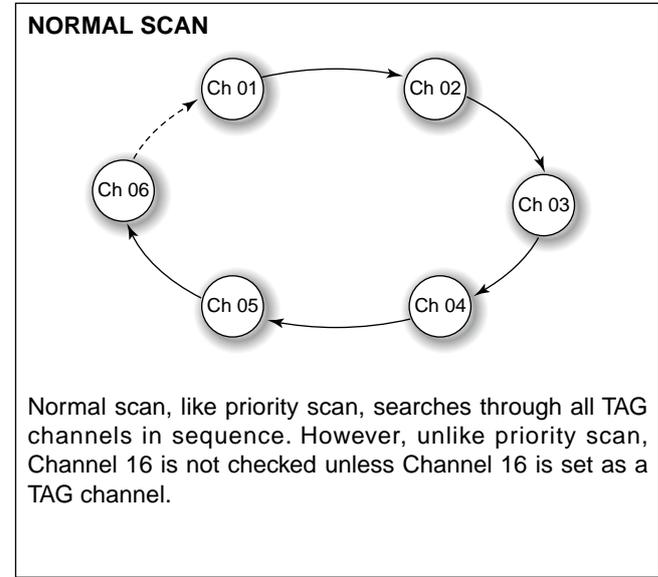

■ Setting TAG channels

For more efficient scanning, add the desired channels as TAG channels or clear the TAG for unwanted channels. Channels that are not tagged will be skipped during scanning. TAG channels can be assigned to each channel group independently.

- ① While pushing and holding **[H/L]**, push **[DIAL]** several times to select the desired channel group.
- ② Select the desired channel to be set as a TAG channel.
- ③ Push **[E]**, then push **[5•TAG]** to set the displayed channel as a TAG channel.
 - “TAG” appears in the display.
- ④ To cancel the TAG channel setting, repeat step ③.
 - “TAG” disappears.

✓ Clearing (or setting) all tagged channels

While pushing and holding **[H/L]**, push **[5•TAG]** for 3 sec. (until a long beep changes to 2 short beeps) to clear all TAG channels setting in the selected channel group.

- Repeat above procedure to set all TAG channels.
-

■ Starting a scan

Set scan type (Priority or Normal scan) and scan resume timer in advance using Set mode. (p. 107)

- ① While pushing and holding **[H/L]**, push **[DIAL]** several times to select the channel group, if desired.
- ② Set TAG channels as described at left.
- ③ Make sure the squelch is closed to start a scan.
- ④ Push **[E]**, then push **[4•SCN]** to start Priority or Normal scan.
 - “PRI-SCAN 16” or “NORMAL SCAN” appears in the display.
 - When a signal is detected, scan pauses until the signal disappears or resumes after pausing 5 sec. according to Set mode setting. (Channel 16 is still monitored during Priority scan.)
 - Rotate **[SELECTOR]** or push **[▲]/[▼]** on the microphone to check the scanning TAG channels, to change the scanning direction or resume the scan manually.
 - A beep tones sounds and “16” blinks when a signal is received on Channel 16 during Priority scan.
- ⑤ To stop the scan, push **[CLR]** or repeat step ④.

[Example]: Starting a normal scan.



↓
Push **F** then push **4GHz SCAN**

↓
Scan starts.

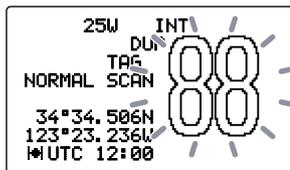

↓
Appears When a signal is received



■ MMSI code programming

The 9-digit MMSI (Maritime Mobile Service Identity: DSC self ID) code can be programmed.

/// This code programming can be performed only once. After the code programming, it can be changed only by your dealer or distributor.

- ① Push **[MENU•MMSI]** to enter MMSI code programming condition.
 - Warning alarm is emitted for 2 sec.
 - If the MMSI code has already been programmed, the MMSI code programming cannot be performed. DSC menu screen appears after pushing **[MENU•MMSI]**.

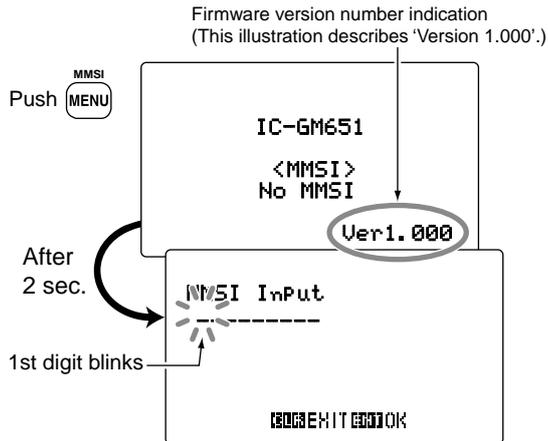

- ② Input the 9-digit of the specific MMSI code directly with the keypad.

- Rotate **[SELECTOR]** to move the cursor backward or forward.
- Push **[CE]** to clear the input code.
- Push **[CLR]** to cancel and exit the condition.

Push

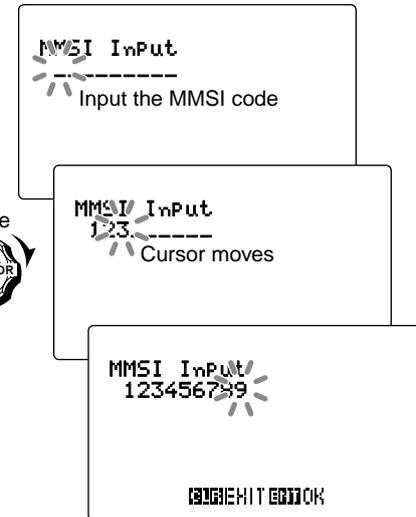

- ③ After inputting the MMSI code, push [ENT].
 • 'Confirmation' line appears.

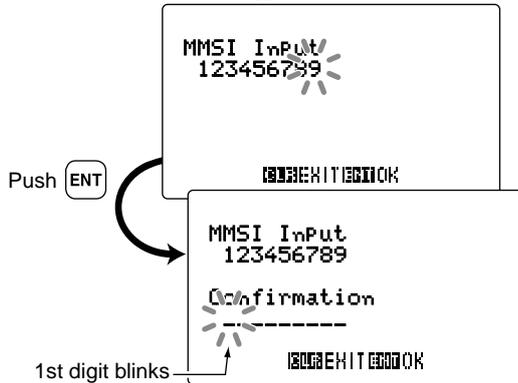

- ④ Input the MMSI code again for the confirmation.



- ⑤ Push [ENT] to set.
 • Return to the normal operation condition.
 • If the different code is input, the code programming is failure. Try steps ② to ④ again.

■ DSC address ID

A total of 100 DSC address IDs can be programmed and named with up to 10 characters.

NOTE: The transceiver automatically returns to the normal operation condition when no operation is performed for 10 minutes in DSC menu.

◇ Programming Individual ID

- ① Push [MENU] to enter the DSC menu.
 ② Rotate [SELECTOR] to select "Set up," push [ENT].

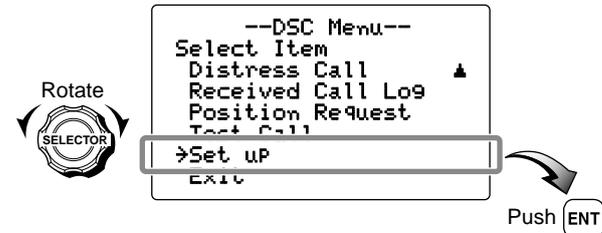

- ③ Rotate [SELECTOR] to select "Add: Individual ID," push [ENT].



6 DSC OPERATION

- ④ Input the 9-digit individual ID directly with the keypad.
- Rotate **[SELECTOR]** to move the cursor backward or forward.
 - Push **[CE]** to clear the ID and name.
 - Push **[CLR]** to cancel and back to the previous screen.

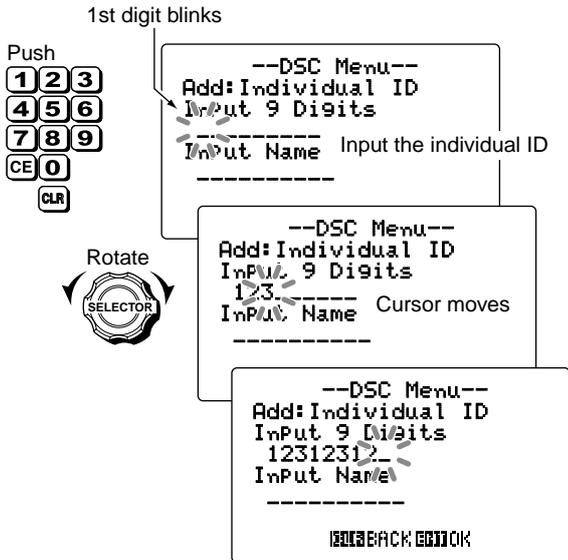

- ⑤ Input the 10-character of the individual ID name directly with the keypad.
- Rotate **[SELECTOR]** to move the cursor backward or forward.
 - Push **[CE]** to clear the ID and name.
 - Push **[CLR]** to cancel and back to the previous screen.

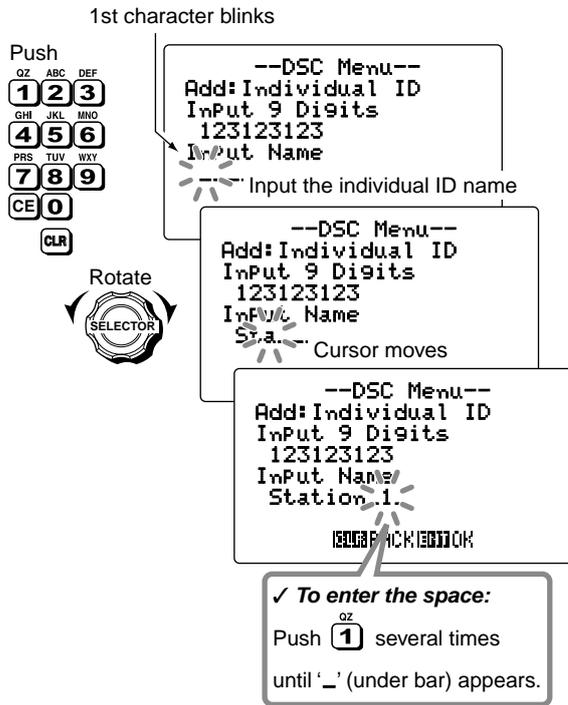

- ⑥ Push [ENT] to program and return to the DSC set up menu.

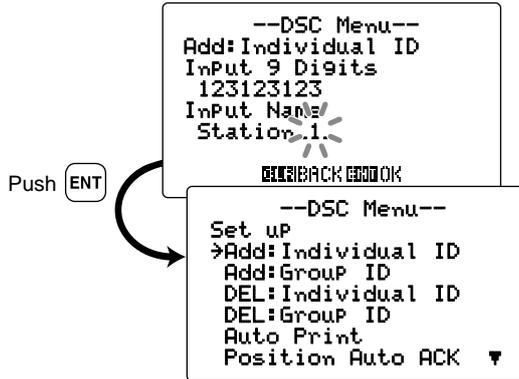

- ⑦ Rotate [SELECTOR] to select "Exit," push [ENT] to return to DSC menu.

• Pushing [CLR] also returns to DSC menu.

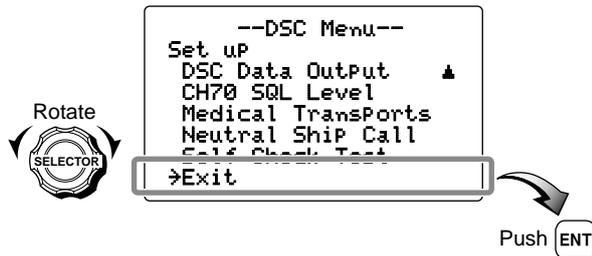

- ⑧ Rotate [SELECTOR] to select "Exit," push [ENT] to return to the normal operation condition.

• Pushing [CLR] also returns to the normal operation condition.

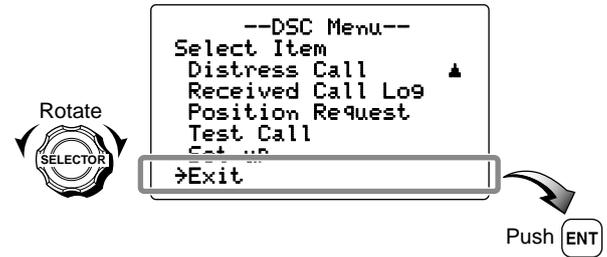

6 DSC OPERATION

◆ Deleting Individual ID

- ① Push **[MENU]** to enter the DSC menu.
- ② Rotate **[SELECTOR]** to select "Set up," push **[ENT]**.

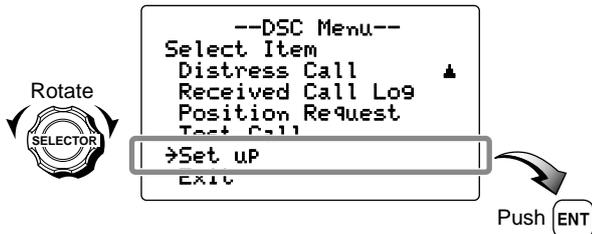

- ③ Rotate **[SELECTOR]** to select "DEL: Individual ID," push **[ENT]**.
 - When no individual ID is programmed, "No ID" is displayed.
 - Push **[CLR]** to cancel and back to the previous screen.



- ④ Rotate **[SELECTOR]** to select the desired ID name for deleting, push **[ENT]**.
 - Push **[CLR]** to cancel and back to the previous screen.

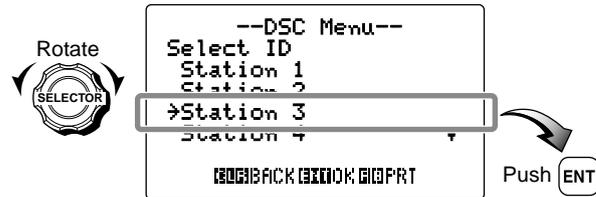

- ⑤ Push **[ENT]** to delete the selected individual ID and return to the ID selection screen.
 - Push **[CLR]** to cancel and back to the previous screen.

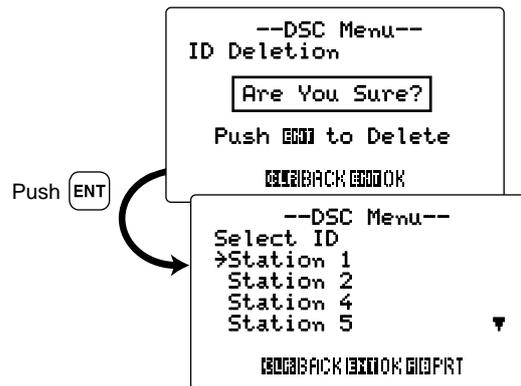

- ⑥ Push **[CLR]** to return to the DSC Set up menu.
 - Push **[ENT]** to delete the selected individual ID. (see step ⑤)
 - Push **[F]**, then push **[8•PRG]** to print out all the programmed individual ID.
- ⑦ Rotate **[SELECTOR]** to select “Exit,” push **[ENT]** to return to DSC menu.
 - Pushing **[CLR]** also returns to DSC menu.

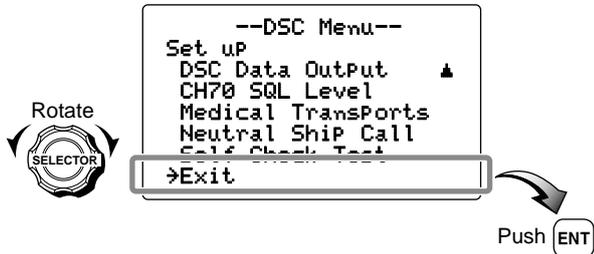

- ⑧ Rotate **[SELECTOR]** to select “Exit,” push **[ENT]** to return to the normal operation condition.
 - Pushing **[CLR]** also returns to the normal operation condition.

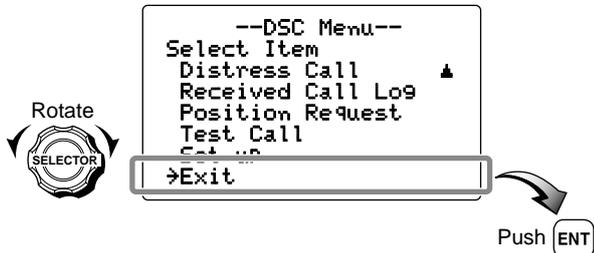

◇ Programming Group ID

- ① Push **[MENU]** to enter the DSC menu.
- ② Rotate **[SELECTOR]** to select “Set uP,” push **[ENT]**.

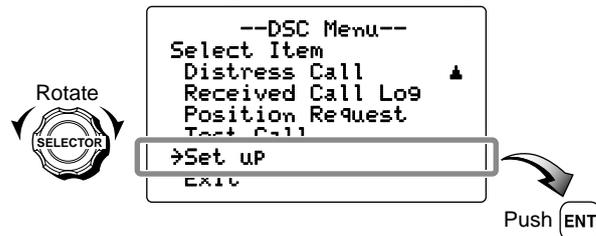

- ③ Rotate **[SELECTOR]** to select “Add:Group ID,” push **[ENT]**.



☞ Continue to the next page

6 DSC OPERATION

- ④ Input the 8-digit group ID directly with the keypad.
- Rotate **[SELECTOR]** to move the cursor backward or forward.
 - Push **[CE]** to clear the ID and name.
 - Push **[CLR]** to cancel and back to the previous screen.
- ⚡ 1st digit '0' is fixed for a Group ID.

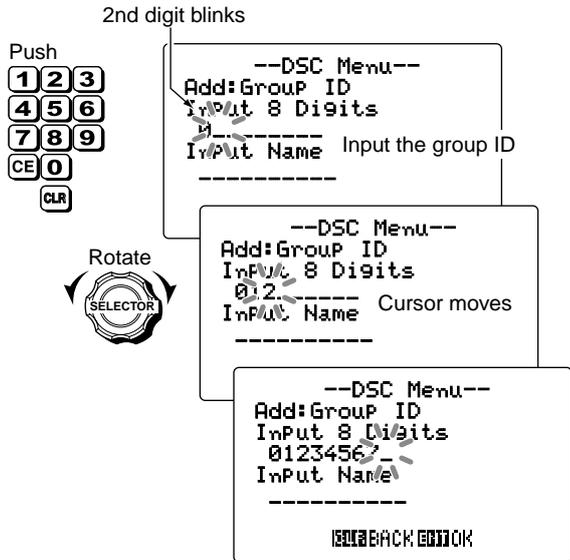

- ⑤ Input the 10-character of the group ID name directly with the keypad.
- Rotate **[SELECTOR]** to move the cursor backward or forward.
 - Push **[CE]** to clear the ID and name.
 - Push **[CLR]** to cancel and back to the previous screen.

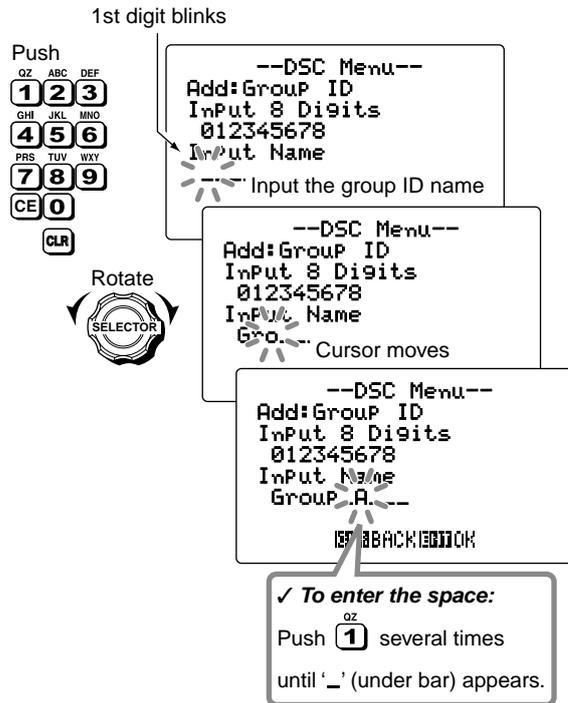

- ⑥ Push [ENT] to program and return to the DSC Set up menu.

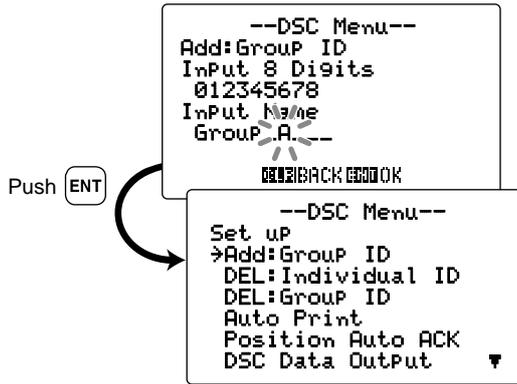

- ⑦ Rotate [SELECTOR] to select "Exit," push [ENT] to return to DSC menu.
- Pushing [CLR] also returns to DSC menu.

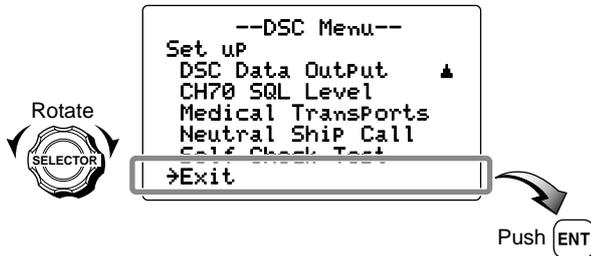

- ⑧ Rotate [SELECTOR] to select "Exit," push [ENT] to return to the normal operation condition.
- Pushing [CLR] also returns to the normal operation condition.

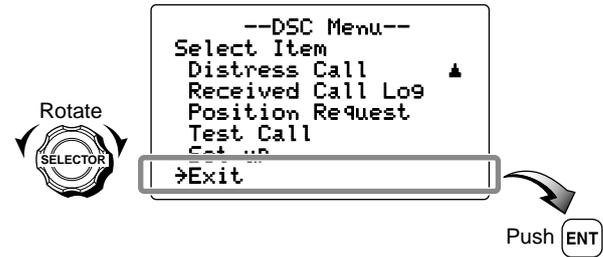

6 DSC OPERATION

◇ Deleting Group ID

- ① Push [MENU] to enter the DSC menu.
- ② Rotate [SELECTOR] to select "Set up," push [ENT].

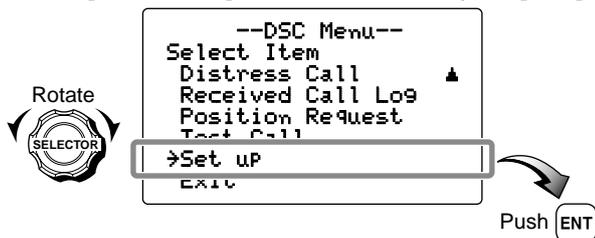

- ③ Rotate [SELECTOR] to select "DEL:Group ID," push [ENT].
 - When no group ID is programmed, "No ID" is displayed. Push [CLR] to cancel and back to the previous screen.



- ④ Rotate [SELECTOR] to select the desired ID name for deleting.
 - Push [CLR] to cancel and back to the previous screen.

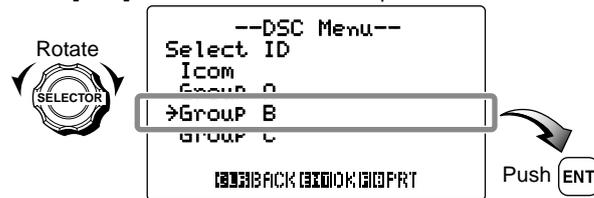

- ⑤ Push [ENT] to delete the selected group ID and return to the ID selection screen.

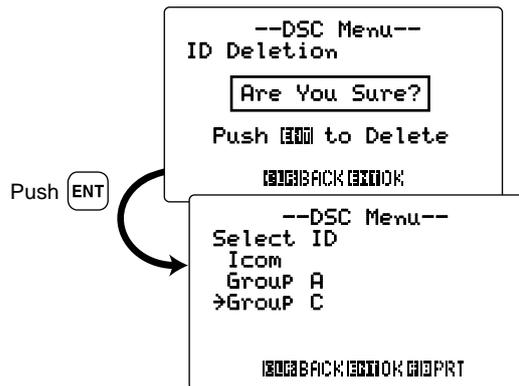

- ⑥ Push **[CLR]** to return to the DSC Set up menu.
 - Push **[ENT]** to delete the selected group ID. (see step ⑤)
 - Push **[G]**, then push **[8•PR1]** to print out all the programmed group ID.
- ⑦ Rotate **[SELECTOR]** to select “Exit,” push **[ENT]** to return to DSC menu.
 - Pushing **[CLR]** also returns to DSC menu.

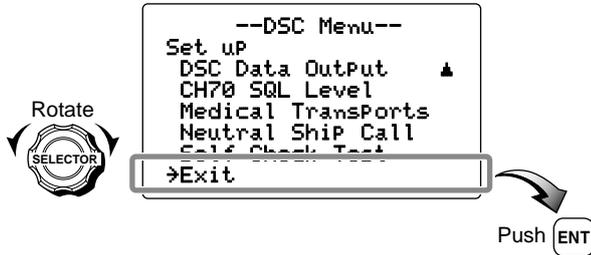

- ⑧ Rotate **[SELECTOR]** to select “Exit,” push **[ENT]** to return to the normal operation condition.
 - Pushing **[CLR]** also returns to the normal operation condition.

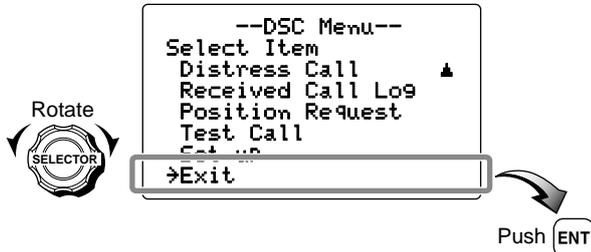

■ Position and Time programming

A Distress call should include the ship’s position and time data. If no GPS is connected, your position and UTC (Universal Time Coordinated) time should be input manually. They are included automatically when a GPS receiver (IEC61162-1: 2000 format) is connected.

- ▨ This manual programming is not available when a GPS receiver (IEC61162-1: 2000 format) is connected.
- ▨ Manually programmed position/time data will be held for 23.5 hours only.

- ① Push **[MENU]** to enter the DSC menu.
- ② Rotate **[SELECTOR]** to select “Position InPut,” push **[ENT]**.

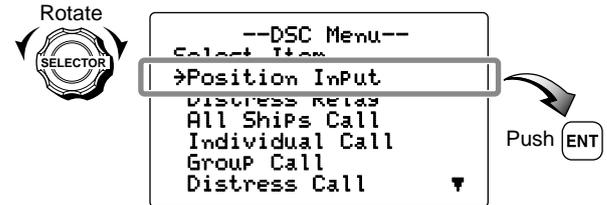

☞ Continue to the next page

6 DSC OPERATION

- ③ Input your latitude data directly with the keypad. After inputting, push **[ENT]** to set.
- Push **[6•MNO]** to input N; North latitude or **[7•PRS]** to input S; South latitude.
 - Rotate **[SELECTOR]** to move the cursor backward or forward.
 - Push **[CE]** to clear the input latitude data. When **[ENT]** is pushed after pushing **[CE]**, no position and time data are set.
 - Push **[CLR]** to cancel and exit the condition.

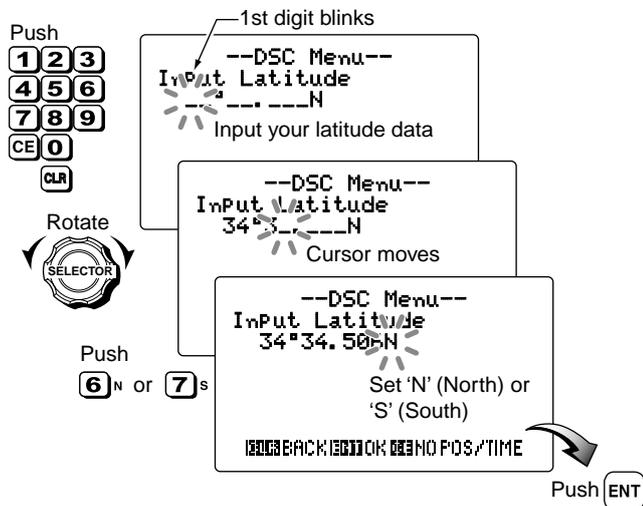

- ④ Input your longitude data directly with the keypad. After inputting, push **[ENT]** to set.
- Push **[9•WXY]** to input W; West longitude or **[3•DEF]** to input E; East longitude.
 - Rotate **[SELECTOR]** to move the cursor backward or forward.
 - Push **[CE]** to clear the input longitude data. When **[ENT]** is pushed after pushing **[CE]**, no position and time data are set.
 - Push **[CLR]** to cancel and exit the condition.

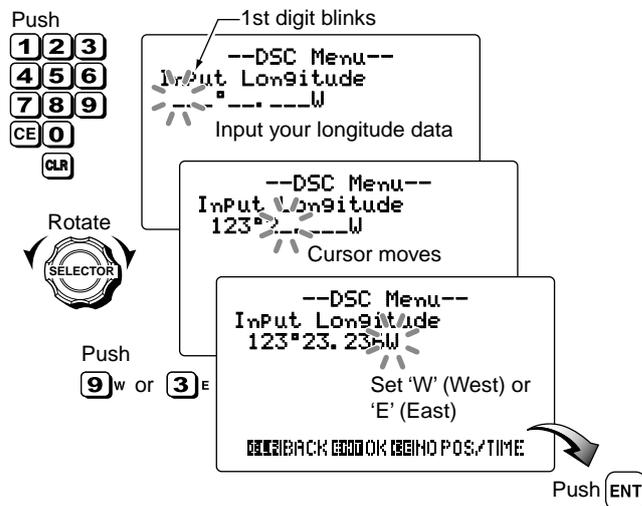

- ⑤ Input the current UTC time with the keypad. After inputting, push **[ENT]** to set.
- Rotate **[SELECTOR]** to move the cursor backward or forward.
 - Push **[CE]** to clear the input time data. When **[ENT]** is pushed after pushing **[CE]**, no position and time data are set.
 - Push **[CLR]** to cancel and back to the previous screen.
 - After pushing **[ENT]**, return to the DSC menu.

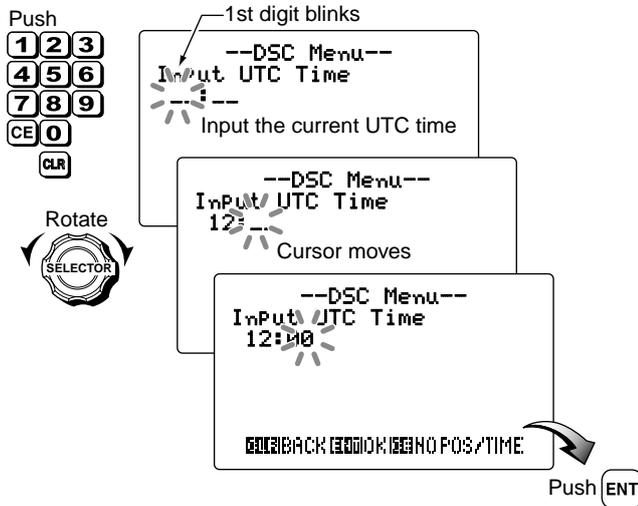

- NOTE:** When no position and time data are input, the following screen appears. Push **[ENT]** to set.
- Push **[CLR]** to cancel and back to the previous screen.



- ⑥ Rotate **[SELECTOR]** to select "Exit," push **[ENT]** to return to the normal operation condition.
- Pushing **[CLR]** also returns to the normal operation condition.

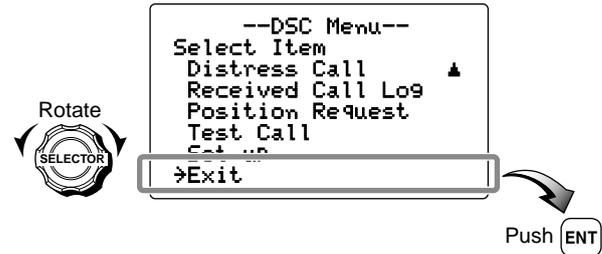

6 DSC OPERATION

When position and time data are set.

The diagram shows a DSC display with the following text: "25W INT TAG 16 CALLING". A dashed box highlights the position and time data: "34°34.506N", "123°23.236W", and "MNL 12:00". A callout box points to this data with the following text:

- Latitude : 34°34.506N
- Longitude : 123°23.236W
- UTC Time : 12:00

When no position and time data are set.

The diagram shows a DSC display with the following text: "25W INT TAG 16 CALLING". A dashed box highlights the text: "No Position" and "No Time". A callout box points to this text with the following text:

"No Position" and "No Time" are displayed.

■ Position and Time indication

When a GPS receiver (IEC61162-1: 2000 format) is connected, the transceiver displays the current position and time ("H") appears.) When no GPS receiver is connected, the transceiver displays the manually entered position and time.

A GPS receiver appropriate for the IC-GM651 is not supplied from Icom. A GPS receiver with IEC61162-1: 2000 format is required for position and time indication. Ask your dealer about suitable GPS receivers.

The diagram shows a DSC display with the following text: "25W INT TAG 16 CALLING". The position and time data is displayed as: "34°34.506N", "123°23.236W", and "H UTC 12:00".

NOTE:

When the transceiver displays the manually entered position and time, "H" does not appear and "MNL" is displayed instead of "UTC".

- ➔ When the connecting GPS receiver is compatible with several sentence formatters, the order of input precedence is 'RMC,' 'GGA,' 'GNS' and 'GLL.'
- ➔ When the GPS data is invalid for 30 sec., "???" may blink instead of position and time indications, and after 10 minutes has passed, the alarm sounds.
- ➔ When the GPS data has not been manually updated after 4 hours, "???" may blink instead of position and time indications, and after 4 hours has passed, the alarm sounds.

■ GPS information indication

When a GPS receiver (IEC61162-1: 2000 format) is connected, the transceiver displays the GPS information after pushing and holding [ENT] for 1 sec.

Push and hold



for 1 sec.

```

--GPS Info--
DATE  : SEP/11/2007
UTC   : 12:00
POS   : 34°34.506N
      : 123°23.236W
COURSE: 261°M
SPEED : 18.5kt
  
```

When connecting GPS receiver is compatible with several sentence formatters, the order of input precedence is 'RMC,' 'GGA,' 'GNS', 'GLL' and 'VTG.'

■ Distress call

A Distress call should be transmitted, if in the opinion of the Master, the ship or a person is in distress and requires immediate assistance.

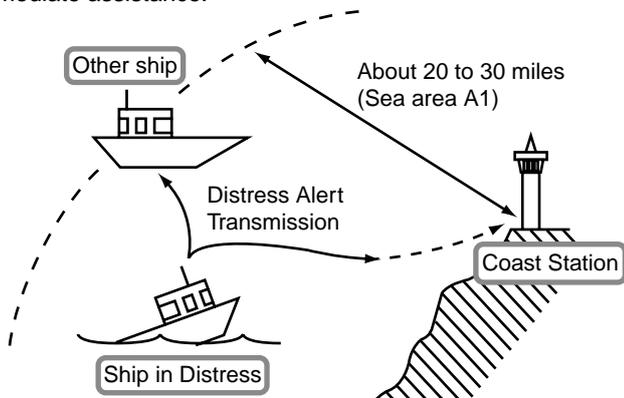

NEVER USE THE DISTRESS CALL WHEN YOUR SHIP OR A PERSON IS NOT IN AN EMERGENCY. A DISTRESS CALL CAN BE USED ONLY WHEN IMMEDIATE HELP IS NEEDED.

◇ Simple call

- ① Confirm no Distress call is being received.
- ② Lift up the key cover, then push and hold **[DISTRESS]** for 3 sec. to transmit the Distress call.
 - Emergency channel (Channel 70) is automatically selected and the Distress call is transmitted.
 - When no GPS is connected, input your position and UTC time, if possible.
 - While pushing **[DISTRESS]**, the key backlight blinks and count-down alarm is emitted.

Push and hold



for 3 sec.

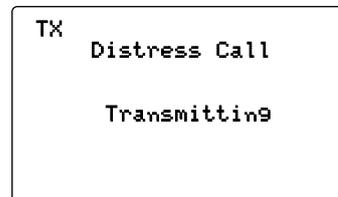
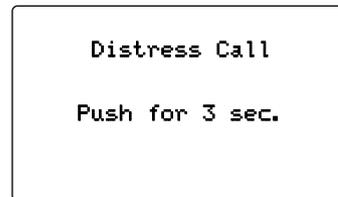

Transmitting

- ③ After transmitting the call, the transceiver waits for an acknowledgment call.
 - The Distress call is automatically transmitted every 3.5 to 4.5 minutes. ('Distress Call Repeat' mode; p. 38)
 - **[PTT]** is activated for voice communication with a maritime station via Channel 16.

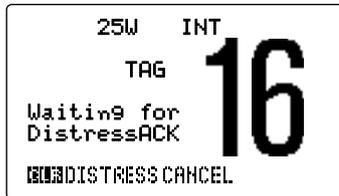

- ④ After receiving the acknowledgment, reply using the microphone.

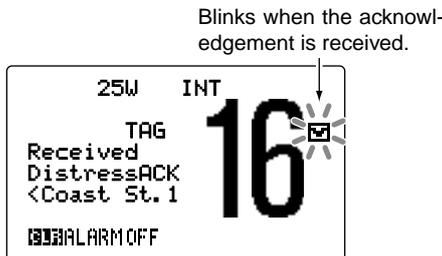

After receiving the acknowledgment from Coast St.1.
 • "<" means "from."

- A distress alert contains (default);
 - Nature of distress : Undesignated distress
 - Position data : GPS or manual input position data held for 23.5 hrs.
- The Distress call is repeated every 3.5–4.5 min., until receiving an 'acknowledgement.' ('Distress Call Repeat' mode; p. 38)
- Push **[CLR]** to transmit the 'Distress Cancel' to cancel the 'Distress Call Repeat' mode. (p. 38)
- Push **[DISTRESS]** to transmit a renewed Distress call, if required.
- "???" may blink instead of position and time indications and the alarm sounds when the GPS data is invalid, or has not been manually updated after 4 hours.
- If the transceiver has no MMSI code, a warning alarm is emitted and "No MMSI" is displayed when **[DISTRESS]** is pushed. In this case, the MMSI code programming screen appears automatically. (p. 18)

6 DSC OPERATION

◆ Regular call

The nature of the distress should be included in the Distress call.

- 1 Push **[MENU]** to enter the DSC menu, then rotate **[SELECTOR]** to select "Distress Call", push **[ENT]**.

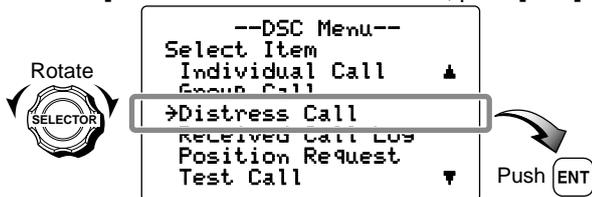

- 2 Rotate **[SELECTOR]** to select the nature of the distress, push **[ENT]**.

- 'Undesignated,' 'Fire, Explosion,' 'Flooding,' 'Collision,' 'Grounding,' 'Capsizing,' 'Sinking,' 'Adrift,' 'Abandoning Ship,' 'Piracy (Piracy attack)' and 'Man Overboard' are available.
- The selected nature of the distress is stored.
- Push **[CLR]** to cancel and back to the previous screen.

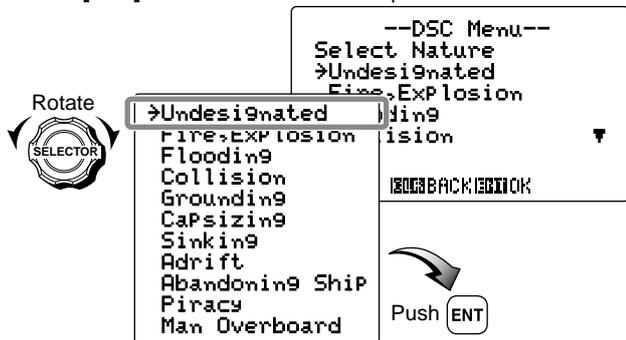

When the transceiver receives the GPS data from the connected GPS receiver, the following screens (steps ③ to ⑤) do not appear. Go to step ⑥ at p. 36.

- 3 Input your latitude data directly with the keypad (if you want to change the displayed data). After inputting, push **[ENT]** to set.
 - If the data is not necessary to be changed, push **[ENT]** to skip the input step.
 - Push **[6•MNO]** to input N; North latitude or **[7•PRS]** to input S; South latitude.
 - Rotate **[SELECTOR]** to move the cursor backward or forward.
 - Push **[CE]** to clear the position and time data. (p. 36)
 - Push **[CLR]** to cancel and back to the previous screen.

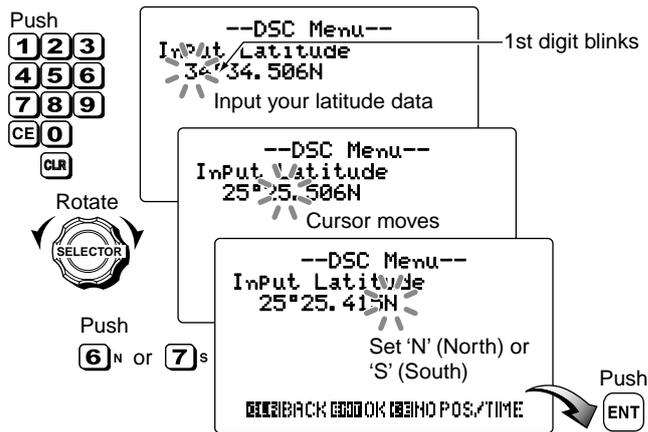

* This illustration shows that the transceiver does not receive the position data from the connected GPS receiver. If the transceiver has no position data, ' _ ' (under bar) is indicated.

- ④ Input your longitude data directly with the keypad (if you want to change the displayed data). After inputting, push [ENT] to set.
- If the data is not necessary to be changed, push [ENT] to skip the input step.
 - Push [9•WXY] to input W; West longitude or [3•DEF] to input E; East longitude.
 - Rotate [SELECTOR] to move the cursor backward or forward.
 - Push [CE] to clear the position and time data. (p. 36)
 - Push [CLR] to cancel and back to the previous screen.

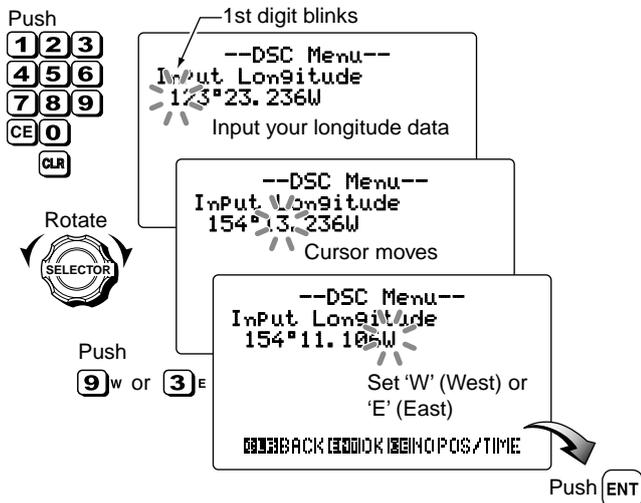

* This illustration shows that the transceiver does not receive the position data from the connected GPS receiver. If the transceiver has no position data, ' _ ' (under bar) is indicated

- ⑤ Input the current UTC time data directly with the keypad (if you want to change the displayed data). After inputting, push [ENT] to set.
- If the data is not necessary to be changed, push [ENT] to skip the input step.
 - Rotate [SELECTOR] to move the cursor backward or forward.
 - Push [CE] to clear the position and time data. (p. 36)
 - Push [CLR] to cancel and back to the previous screen.

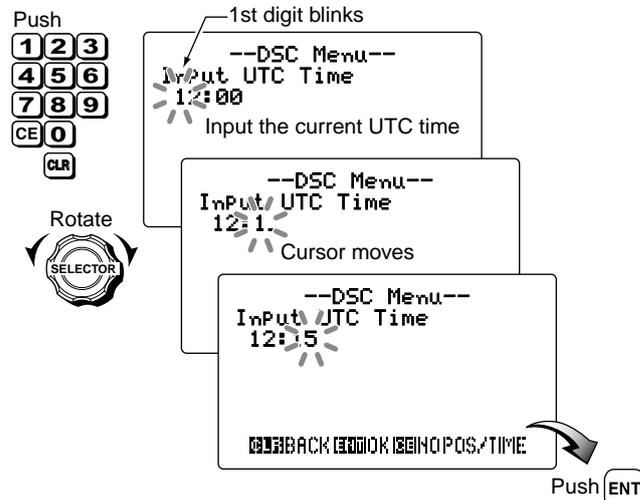

* This illustration shows that the transceiver does not receive the UTC time data from the connected GPS receiver. If the transceiver has no time data, ' _ ' (under bar) is indicated.

6 DSC OPERATION

NOTE: When no position and time data are input, the following screen appears. Push **[ENT]** to set.

- Push **[CLR]** to cancel and back to the previous screen.

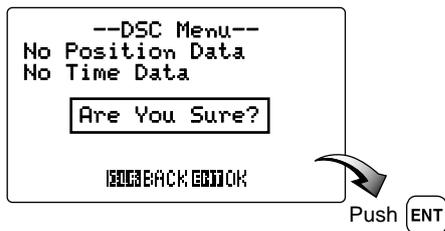

- ⑥ Push and hold **[DISTRESS]** for 3 sec. to transmit the Distress call.

- Emergency channel (Channel 70) is automatically selected and the Distress call is transmitted.
- While pushing **[DISTRESS]**, the key backlight blinks and count-down alarm is emitted.
- The distress information is stored.
- Push **[CLR]** to exit the condition.

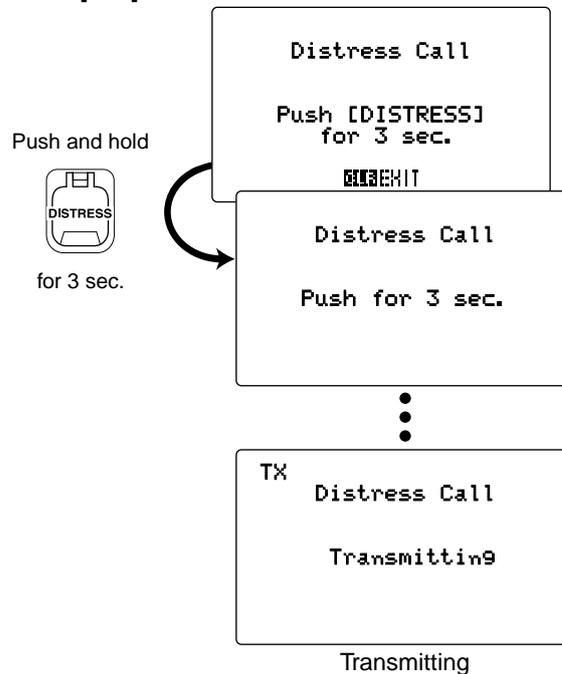

- ⑦ After transmitting the Distress call, the transceiver waits for an acknowledgment call.
- The Distress call is automatically transmitted every 3.5 to 4.5 minutes. ('Distress Call Repeat' mode; p. 38)
 - **[PTT]** is activated for voice communication with a maritime station via Channel 16.

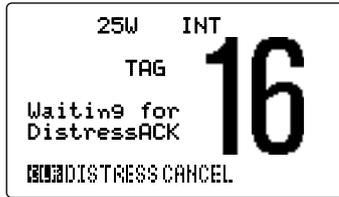

- ⑧ After receiving the acknowledgment, reply using the microphone.

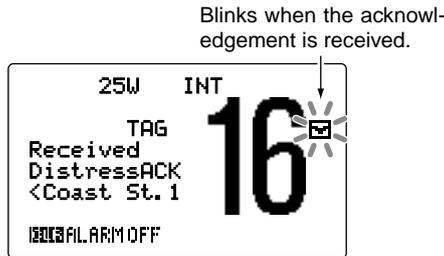

After receiving the acknowledgment from Coast St.1.

- "<" means "from."

- The Distress call is repeated every 3.5–4.5 min., until receiving an 'acknowledgement.' ('Distress Call Repeat' mode; p. 38)
- Push **[CLR]** to transmit the 'Distress Cancel' to cancel the 'Distress Call Repeat' mode. (p. 38)
- Push **[DISTRESS]** to transmit a renewed Distress call, if required.
- "???" may blink instead of position and time indications and the alarm sounds when the GPS data is invalid, or has not been manually updated after 4 hours.

6 DSC OPERATION

• About the 'Distress Call Repeat' mode

The Distress call is automatically repeated every 3.5–4.5 min., until receiving an 'acknowledgement.'

To cancel the 'Distress Call Repeat' mode, transmit the Distress Cancel as at right.

- ① After 3.5–4.5 min has passed from transmitting the Distress call, the key backlight starts blinking and countdown alarm is emitted automatically. After 3 sec., the distress call re-transmission is performed.

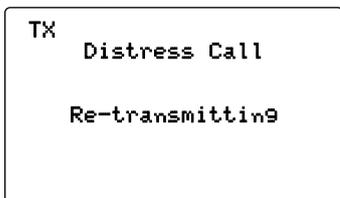

Transmitting

- ② After transmitting the Distress call, the transceiver waits for an acknowledgment call.

◇ Transmitting a Distress Cancel

Distress Cancel call operation is available only when the transceiver is waiting for an 'acknowledgement' call after transmitting the Distress call. ('Distress Call Repeat' mode)

- ① While waiting for the Distress acknowledgement call after transmitting the Distress call, push **[CLR]**.
 - 'Distress Call Repeat' mode is canceled.



- ② Push **[ENT]** to transmit the Distress Cancel.
 - Emergency channel (Channel 70) is automatically selected.
 - Push **[CLR]** to cancel and back to the previous condition.

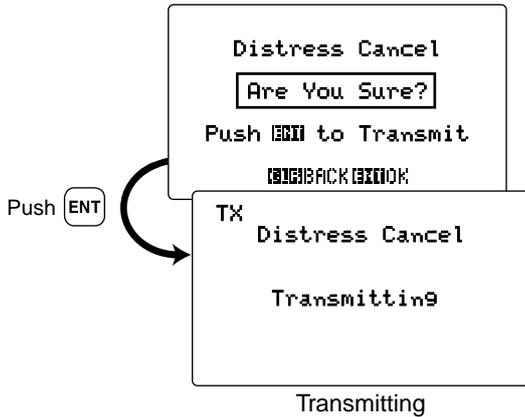

③ After 2 sec., the transceiver returns to the normal operation condition.

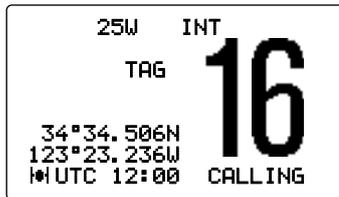

◇ Transmitting a Distress Acknowledgement call

Distress call reception should stop after one sequence since the coast station should send back an 'acknowledgement' to the ship. If the distress call continues even the coast station send back an 'acknowledgement,' the ship in distress may not be receiving the call.

In such cases, you should contact the coast station via the phone and send back an 'acknowledgement' on behalf of the coast station if the coast station requires.

- ① Push [MENU] to enter the DSC menu, then rotate [SELECTOR] to select "Distress ACK," push [ENT].
 - "Distress ACK" is added to the DSC menu after receiving a distress call.

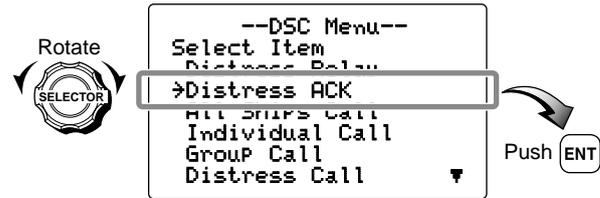

- ② Rotate [SELECTOR] to select the address, push [ENT]



6 DSC OPERATION

- ③ The distress information appears. Push [ENT].



- ④ Push [ENT] to transmit the Distress Acknowledgement call.
• Emergency channel (Channel 70) is automatically selected.

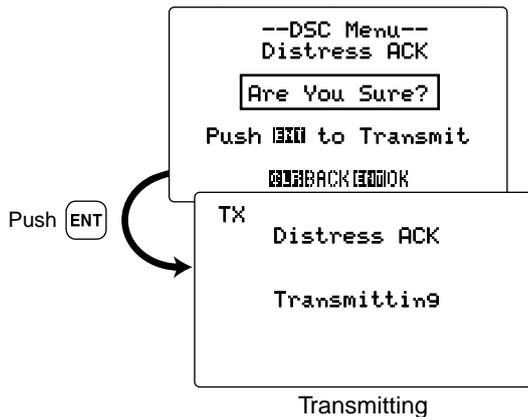

- ⑤ After transmitting the Distress Acknowledgement call, the transceiver selects the Channel 16 automatically.



◇ Transmitting a Distress Relay call

There are two ways to transmit the distress relay call—“DROBOSE (Distress Relay On Behalf Of Someone Else)” and “Distress Relay Call with Distress Call Log”.

/// **DO NOT** push [DISTRESS] to transmit a distress relay call; it is used for the own distress call.

To transmit the distress relay call with “DROBOSE”:

You may transmit a distress relay call when a ship in distress is in a position where the distress call cannot be transmitted, or when you find a ship in distress and a quick help is needed.

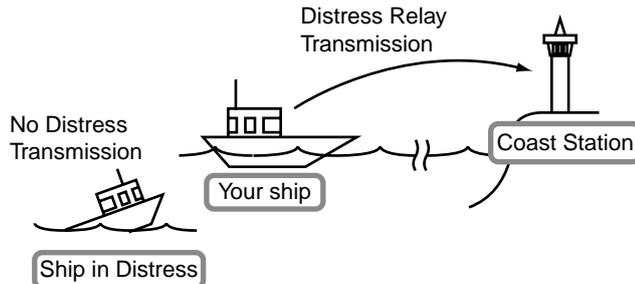

- ① Push [MENU] to enter the DSC menu, then rotate [SELECTOR] to select “Distress Relay,” push [ENT].

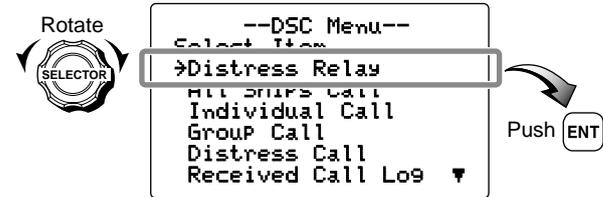

- ② Rotate [SELECTOR] to select the address, push [ENT].



/// When “All Ships” is selected, step ③ does not appear. Go to step ④.

☞ Continue to the next page

6 DSC OPERATION

- ③ Rotate **[SELECTOR]** to select the desired pre-programmed coast station address or “Manual Input” for transmitting a distress relay call, push **[ENT]**.
- The ID code can be set in advance. (p. 19)



When the pre-programmed address is selected.

- When “Manual Input” is selected, set the 7-digit address ID you wish to call with the keypad, push **[ENT]**.

- 1st and 2nd digits '00' are fixed for a coast station ID.



- ④ Distress ID of the ship in distress selection screen appears. Rotate **[SELECTOR]** to select “Manual Input,” push **[ENT]**.



Distress Call Log is displayed after receiving the Distress Call. Do not select for DROBOSE.

- ⑤ Input the 9-digit Distress ID (MMSI ID) code of the ship in distress that you wish to help with the keypad.
- Rotate **[SELECTOR]** to move the cursor backward or forward.
 - Push **[CE]** to clear the input data.
 - Push **[CLR]** to cancel and back to the previous condition.
 - If nothing is input, MMSI ID code is set as "Null."

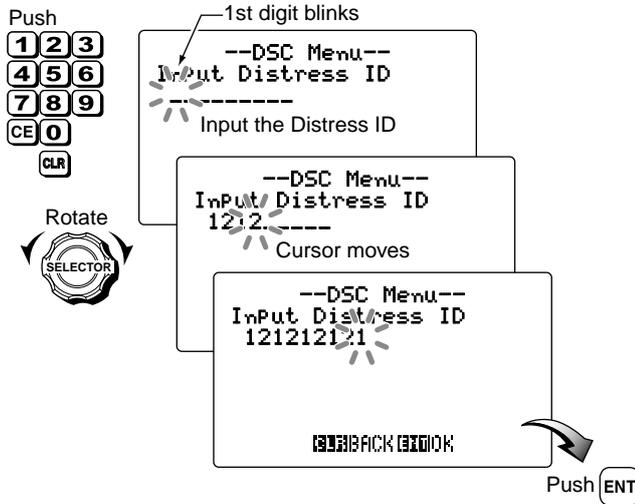

- ⑥ Rotate **[SELECTOR]** to select the nature of the distress, push **[ENT]**.
- 'Undesignated,' 'Fire Explosion,' 'Flooding,' 'Collision,' 'Grounding,' 'Capsizing,' 'Sinking,' 'Adrift,' 'Abandoning Ship,' 'Piracy (Piracy attack),' 'Man Overboard' and 'EPIRB Emission' are available.
 - The selected nature of the distress is stored after selecting is finished.

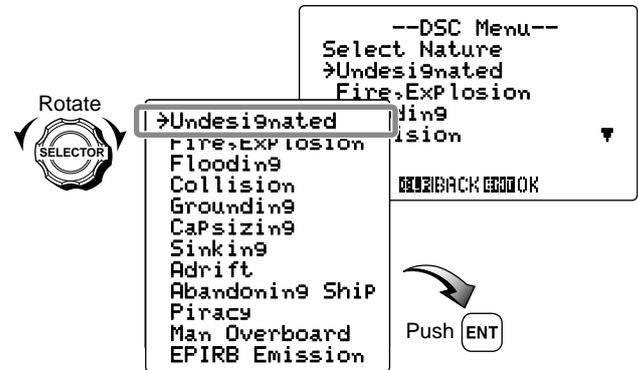

☞ Continue to the next page

6 DSC OPERATION

- ⑦ Your position data is displayed. Input the ship in distress latitude data directly with the keypad. After inputting, push **[ENT]** to set.
- If the data is not necessary to be changed, push **[ENT]** to skip the input step.
 - Push **[6•MNO]** to input N; North latitude or **[7•PRS]** to input S; South latitude.
 - Rotate **[SELECTOR]** to move the cursor backward or forward.
 - Push **[CE]** to clear the position and time data. (p. 45)
 - Push **[CLR]** to cancel and back to the previous screen.

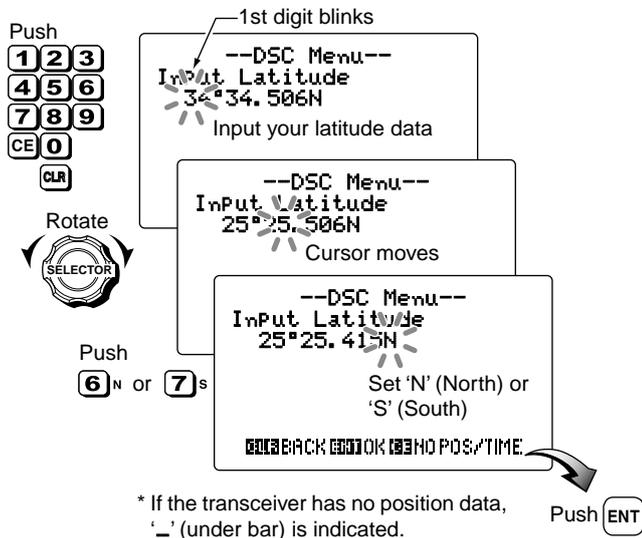

- ⑧ Input the ship in distress longitude data directly with the keypad. After inputting, push **[ENT]** to set.
- If the data is not necessary to be changed, push **[ENT]** to skip the input step.
 - Push **[9•WXY]** to input W; West longitude or **[3•DEF]** to input E; East longitude.
 - Rotate **[SELECTOR]** to move the cursor backward or forward.
 - Push **[CE]** to clear the position and time data. (p. 45)
 - Push **[CLR]** to cancel and back to the previous screen.

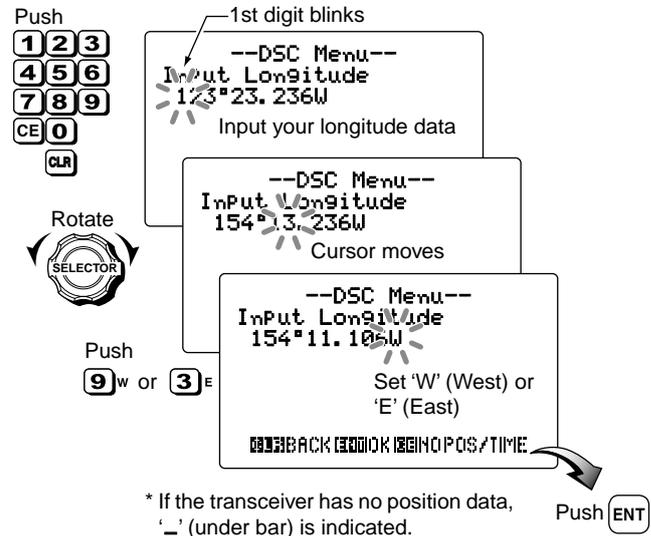

- ⑨ Input the current UTC time with the keypad. After inputting, push [ENT] to set.
- If the data is not necessary to be changed, push [ENT] to skip the input step.
 - Rotate [SELECTOR] to move the cursor backward or forward.
 - Push [CE] to clear the position and time data. (see at right)
 - Push [CLR] to cancel and back to the previous screen.

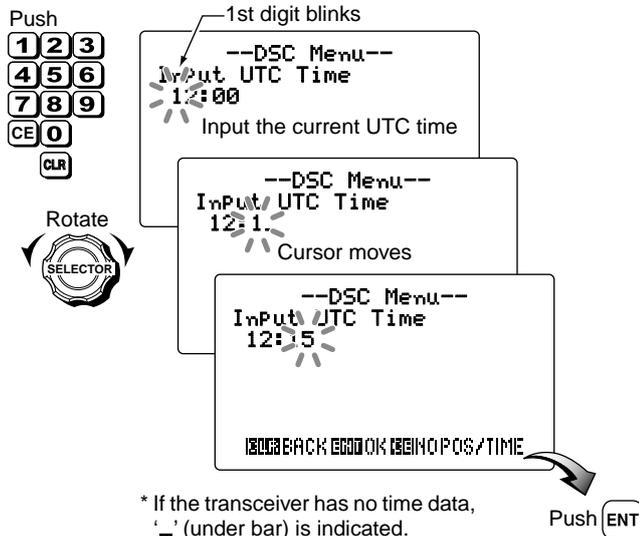

NOTE: When no position and time data are input, the following screen appears. Push [ENT] to set.

- Push [CLR] to cancel and back to the previous screen.



6 DSC OPERATION

- ⑩ Push **[ENT]** to transmit the distress relay call.
- Emergency channel (Channel 70) is automatically selected.

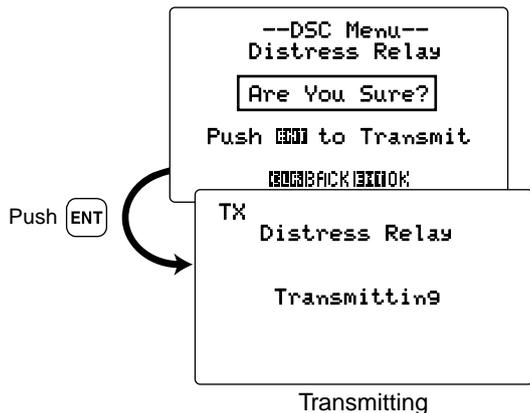

- ⑪ After transmitting the Distress Relay call, the transceiver returns to the normal operation condition.
- **[PTT]** is activated for voice communication with a maritime station via Channel 16.



To transmit the distress relay call with “Distress Call Log”:
You can relay a distress call after receiving the distress call.

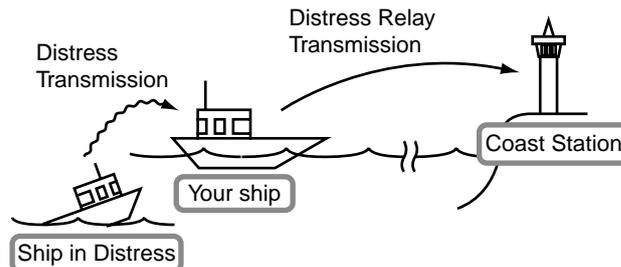

- ① After receiving the distress call (p. 75), push **[MENU]** to enter the DSC menu, then rotate **[SELECTOR]** to select “Distress Relay,” push **[ENT]**.

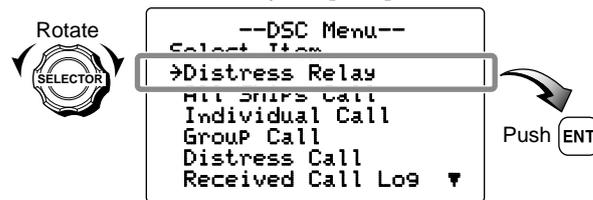

- ② Rotate **[SELECTOR]** to select the desired destination.



When "ALL SHIPS" is selected, step ③ does not appear. Go to step ④.

- ③ Rotate [SELECTOR] to select the desired pre-programmed coast station address or "Manual Input" for transmitting a distress relay call, push [ENT].
 - The ID code can be set in advance. (p. 19)



When the pre-programmed address is selected.

When "Manual Input" is selected, set the 7-digit address ID you wish to call with the keypad, push [ENT].

- 1st and 2nd digits '00' are fixed for a coast station ID.



- ④ Distress ID of the ship in distress selection screen appears. Rotate [SELECTOR] to select the desired distress ID from the distress call log, push [ENT].



Distress Call Log is displayed after receiving the Distress Call.

- ⑤ The distress information appears. Push [ENT].



6 DSC OPERATION

- ⑥ Push **[ENT]** to transmit the distress relay call.
- Emergency channel (Channel 70) is automatically selected.

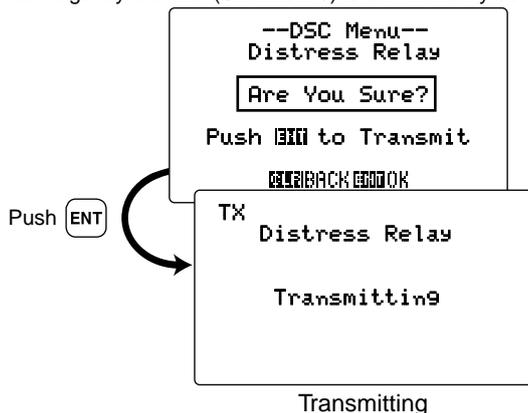

- ⑦ After transmitting the Distress Relay call, the transceiver returns to the normal operation condition.
- **[PTT]** is activated for voice communication with a maritime station via Channel 16.

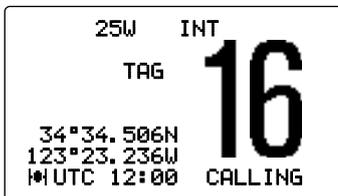

◆ **Transmitting a Distress Relay Acknowledgement call**
Distress relay acknowledgement call operation is available only when the distress relay call is received.

- ① Push **[MENU]** to enter the DSC menu, then rotate **[SELECTOR]** to select "Distress Relay ACK," push **[ENT]**.
- "Distress Relay ACK" is added to the DSC menu after receiving an Distress Relay call.

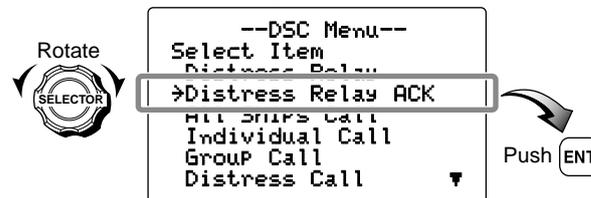

- ② Rotate **[SELECTOR]** to select the address, push **[ENT]**



③ The distress information appears. Push [ENT].



⑤ After transmitting the Distress Relay Acknowledgement call, the transceiver selects the Channel 16 automatically.

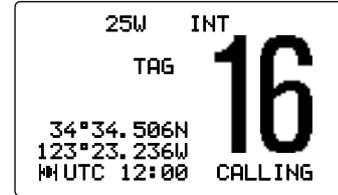

④ Push [ENT] to transmit the Distress Relay Acknowledgement call.

- Emergency channel (Channel 70) is automatically selected.

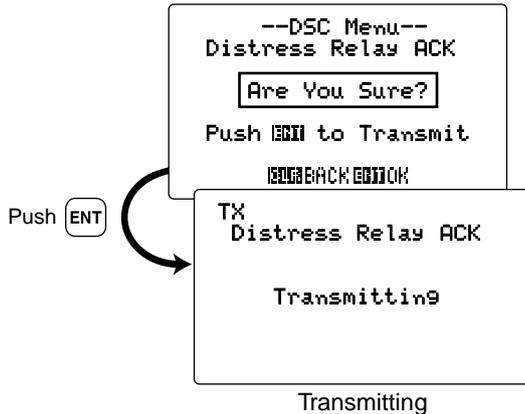

■ Transmitting DSC calls

▨ To ensure correct operation of the DSC function, please
▨ make sure you set the squelch correctly. (p. 102)

◆ Transmitting an All Ships call

Large ships use Channel 70 as their 'listening channel.'
When you want to announce a message to all ships within
range, use the 'All Ships Call' function.

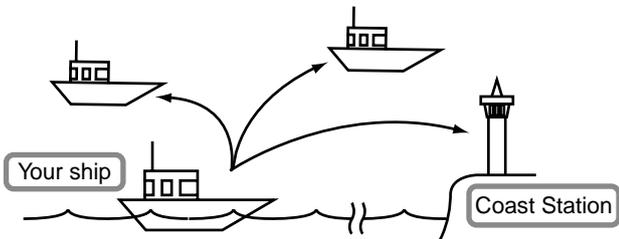

① Push [MENU] to enter the DSC menu, then rotate [SELECTOR] to select "All Ships Call," push [ENT].

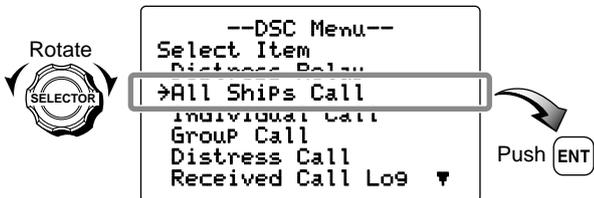

② Rotate [SELECTOR] to select the desired category, push [ENT].



③ Rotate [SELECTOR] to select a desired traffic channel from the list as below, push [ENT].



01	06	11	16	21	26	62	67	73	78	83	88
02	07	12	17	22	27	63	68	74	79	84	
03	08	13	18	23	28	64	69	75	80	85	
04	09	14	19	24	60	65	71	76	81	86	
05	10	15	20	25	61	66	72	77	82	87	

- ④ Push [ENT] to transmit the All ships call.
- Emergency channel (Channel 70) is automatically selected.
 - If Channel 70 is busy, the transceiver stands by until the channel becomes clear.

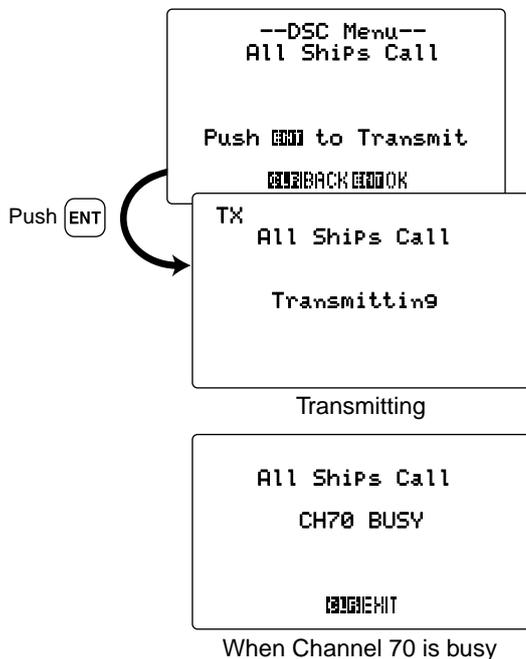

- ⑤ After the All ships call has been transmitted, the transceiver selects the traffic channel (specified in step ③) automatically.

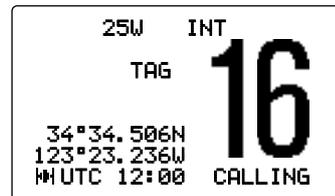

6 DSC OPERATION

◇ Transmitting an Individual call

The Individual call function allows you to transmit a DSC signal to a specific coast station or ship only. After transmission, wait to receive the acknowledgement call from the receiving station. The voice communication can be performed after receiving the acknowledgement 'Able to comply.'

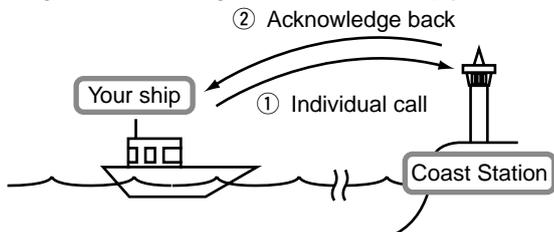

• General procedure for transmitting an Individual call:

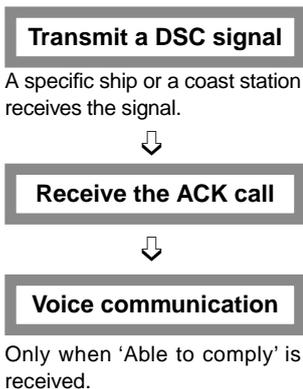

- ① Push **[MENU]** to enter the DSC menu, then rotate **[SELECTOR]** to select "Individual Call," push **[ENT]**.

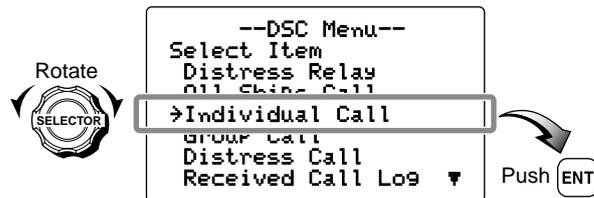

- ② Rotate **[SELECTOR]** to select the desired pre-programmed individual address or "Manual Input," push **[ENT]**.
 - The ID code for the Individual call can be set in advance. (p. 19)



When the pre-programmed address is selected.

When "Manual Input" is selected, set the 9-digit individual ID you wish to call with the keypad, push [ENT].



③ Rotate [SELECTOR] to select the desired category, push [ENT].



When the coast station address is selected in step ②, step ④ does not appear. Go to step ⑤.

④ Rotate [SELECTOR] to select the desired intership channel or "Manual Input," push [ENT].

- Intership channels are already preset into the transceiver in recommended order.

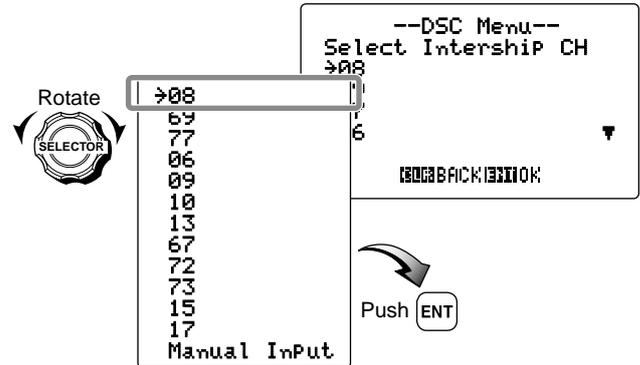

When "Manual Input" is selected, rotate [SELECTOR] to select the desired channel. The following channels can be set;

01	06	11	16	21	26	62	67	73	78	83	88
02	07	12	17	22	27	63	68	74	79	84	
03	08	13	18	23	28	64	69	75	80	85	
04	09	14	19	24	60	65	71	76	81	86	
05	10	15	20	25	61	66	72	77	82	87	

Continue to the next page

6 DSC OPERATION

- ⑤ Push **[ENT]** to transmit the Individual call.
- Emergency channel (Channel 70) is automatically selected.
 - If Channel 70 is busy, the transceiver stands by until the channel becomes clear.

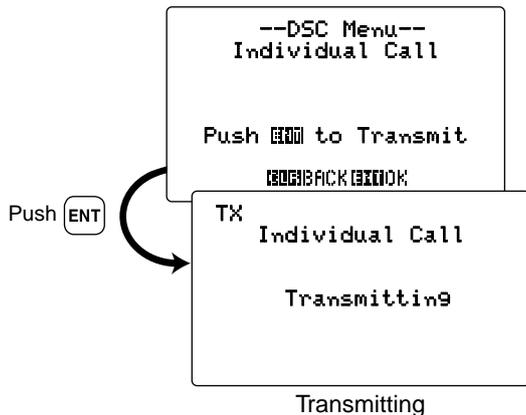

- ⑥ After the Individual call has been transmitted, the transceiver automatically returns to the previous indication (before entering the DSC menu.)
- ⑦ After receiving the acknowledgement call (“Able to comply”), the voice communication can be performed with the responding ship. See p. 83 for details.

◇ Transmitting an Individual Acknowledgement call

When receiving an Individual call, you can transmit an acknowledgement call ('Able to comply', 'Propose New Channel' or 'Unable to comply') by using the on screen prompts (Quick ACK). Also, you can send an acknowledgement through the menu system (Manual ACK).

To transmit “Able to Comply”— Quick ACK:

- ➔ After an Individual call is received, push **[CLR]** to stop the alarm, then rotate **[SELECTOR]** to indicate the received message log. And then, push **[ENT]**. (Go to step ④ as at right.)



To transmit “Able to Comply”— Manual ACK:

- ① Push [MENU] to enter the DSC menu, then rotate [SELECTOR] to select “Individual ACK,” push [ENT].
 - “Individual ACK” is added to the DSC menu after receiving an Individual call.

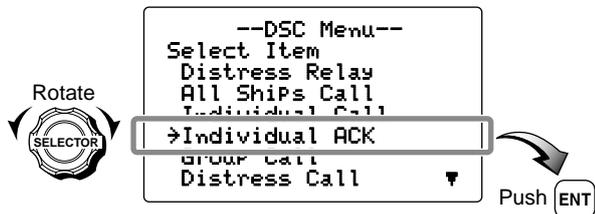

- ② Rotate [SELECTOR] to select the desired individual address or ID code, push [ENT].

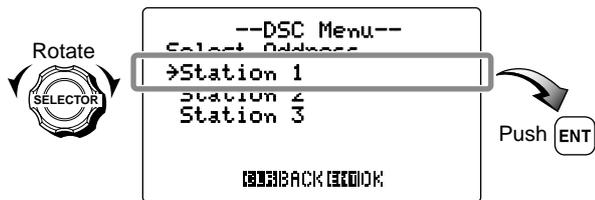

- ③ The call information appears, push [ENT].

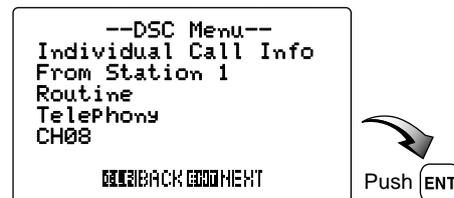

- ④ Rotate [SELECTOR] to select “Able to Comply,” push [ENT].



☞ Continue to the next page

6 DSC OPERATION

- ⑤ Push [ENT] to transmit the Individual acknowledgement call to the calling station.
- Emergency channel (Channel 70) is automatically selected.
 - If Channel 70 is busy, the transceiver stands by until the channel becomes clear.

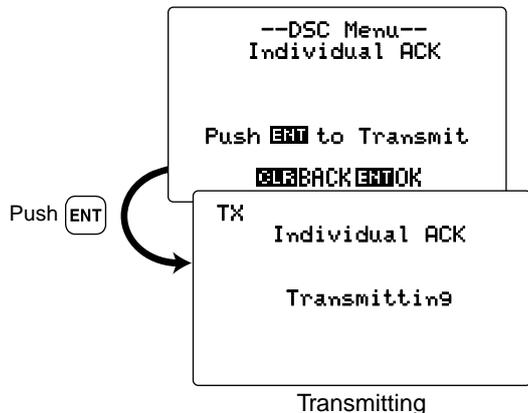

- ⑥ After the Individual acknowledgement call has been transmitted, the specified channel (specified by the calling station) is selected automatically.



To transmit "Propose New Channel"— Quick ACK:

- ➔ After an Individual call is received, push [CLR] to stop the alarm, then rotate [SELECTOR] to indicate the received message log. And then, push [ENT]. (Go to step ④ as at right.)



To transmit "Propose New Channel"— Manual ACK:

- ① Push [MENU] to enter the DSC menu, then rotate [SELECTOR] to select "Individual ACK," push [ENT].
- "Individual ACK" is added to the DSC menu after receiving an Individual call.

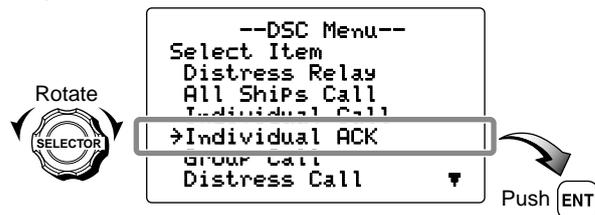

- ② Rotate **[SELECTOR]** to select the desired individual address or ID code, push **[ENT]**.



- ③ The call information appears, push **[ENT]**.

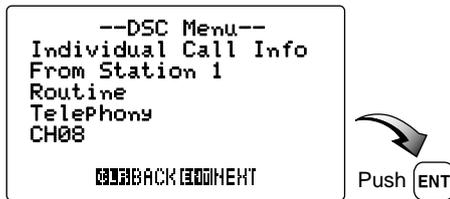

- ④ Rotate **[SELECTOR]** to select "Propose New Channel," push **[ENT]**.



- ⑤ Rotate **[SELECTOR]** to select a desired intership channel or "Manual Input," push **[ENT]**.

- Intership channels are already preset into the transceiver in recommended order.

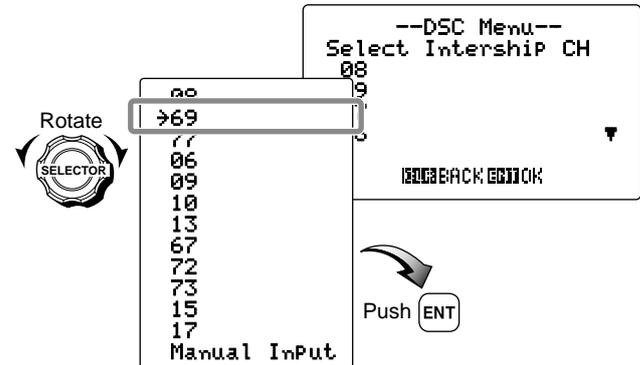

When "Manual Input" is selected, rotate **[SELECTOR]** to select the desired channel. The following channels can be set;

01	06	11	16	21	26	62	67	73	78	83	88
02	07	12	17	22	27	63	68	74	79	84	
03	08	13	18	23	28	64	69	75	80	85	
04	09	14	19	24	60	65	71	76	81	86	
05	10	15	20	25	61	66	72	77	82	87	

☞ Continue to the next page

6 DSC OPERATION

- ⑥ Push [ENT] to transmit the Individual acknowledgement call to the calling station.
- Emergency channel (Channel 70) is automatically selected.
 - If Channel 70 is busy, the transceiver stands by until the channel becomes clear.

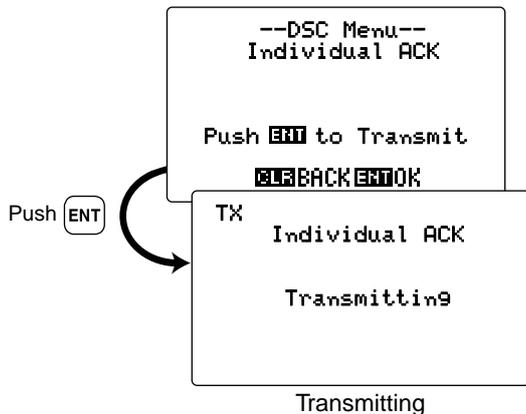

- ⑦ After the Individual acknowledgement call has been transmitted, the specified channel (specified in step ⑤) is selected automatically.

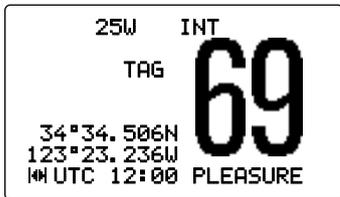

To transmit "Unable to Comply"— Quick ACK:

- ➔ After an Individual call is received, push [CLR] to stop the alarm, then rotate [SELECTOR] to indicate the received message log. And then, push [ENT]. (Go to step ④ as at p. 59.)

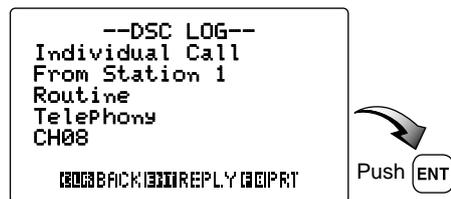

To transmit "Unable to Comply"— Manual ACK:

- ① Push [MENU] to enter the DSC menu, then rotate [SELECTOR] to select "Individual ACK," push [ENT].
- "Individual ACK" is added to the DSC menu after receiving an Individual call.

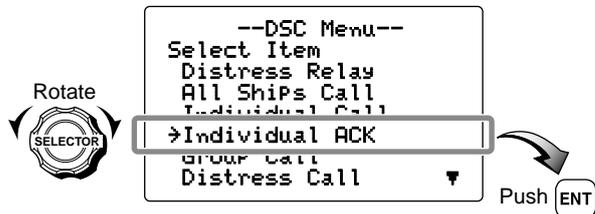

- ② Rotate **[SELECTOR]** to select the desired individual address or ID code, push **[ENT]**.



- ③ The call information appears, push **[ENT]**.

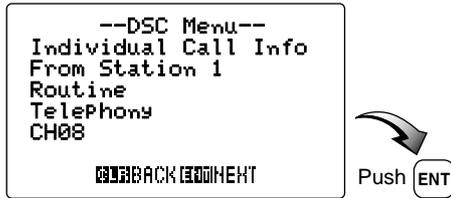

- ④ Rotate **[SELECTOR]** to select "Unable to Comply," push **[ENT]**.



- ⑤ Rotate **[SELECTOR]** to select the reason, push **[ENT]**.
 • The selected reason will be transmitted.

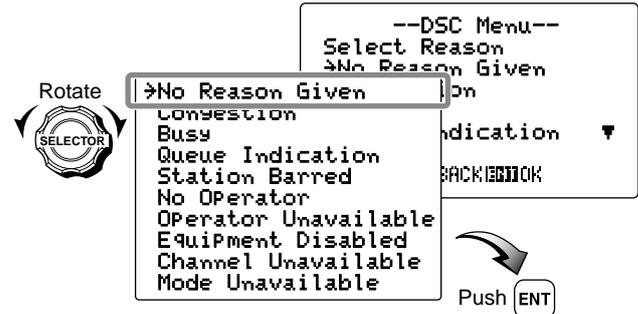

➤ Continue to the next page

6 DSC OPERATION

- ⑥ Push [ENT] to transmit the Individual acknowledgement call to the calling station.
- Emergency channel (Channel 70) is automatically selected.
 - If Channel 70 is busy, the transceiver stands by until the channel becomes clear.

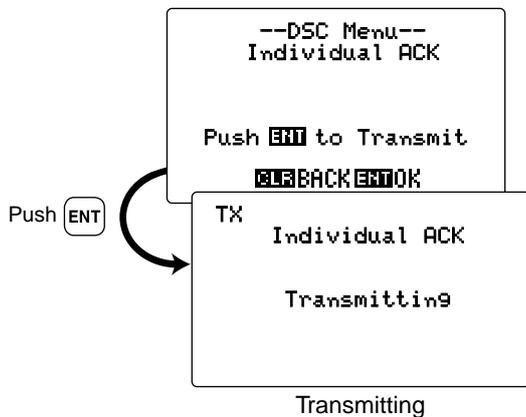

- ⑦ After the Individual acknowledgement call has been transmitted, returns to the previous condition (before entering the DSC menu).

◇ Transmitting a Group call

The Group call function allows you to transmit a DSC signal to a specific group only.

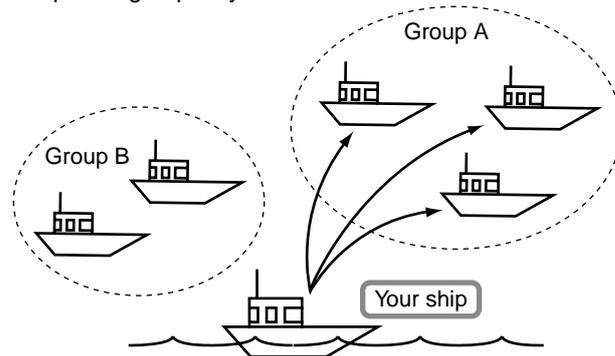

- ① Push [MENU] to enter the DSC menu, then rotate [SELECTOR] to select "Group Call," push [ENT].

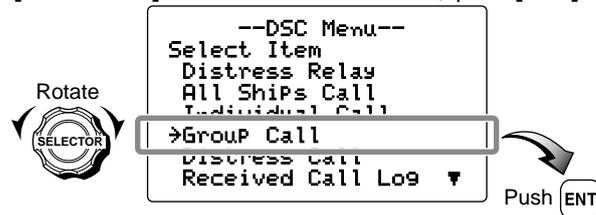

6 DSC OPERATION

- ④ Push **[ENT]** to transmit the Group call.
- Emergency channel (Channel 70) is automatically selected.
 - If Channel 70 is busy, the transceiver stands by until the channel becomes clear.

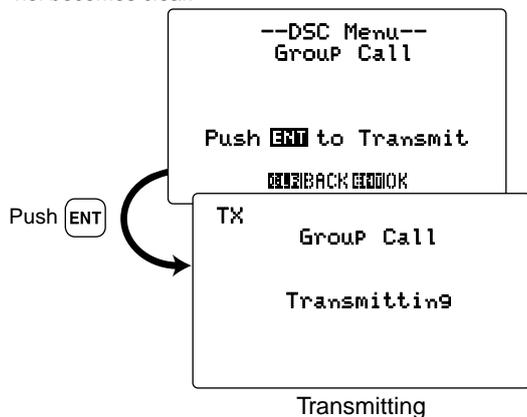

- ⑤ After the Group call has been transmitted, the transceiver selects the specified intership channel in step ③ automatically.
- ⑥ Push and hold **[PTT]** to announce your message to the specified group ships.

◇ Transmitting a Position Request call

Transmit a Position Request call when you want to know a specific ship's current position, etc.

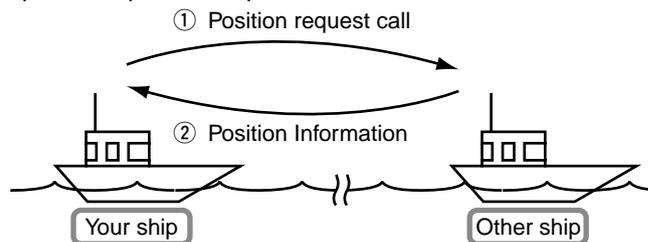

- ① Push **[MENU]** to enter the DSC menu, then rotate **[SELECTOR]** to select "Position Request," push **[ENT]**.

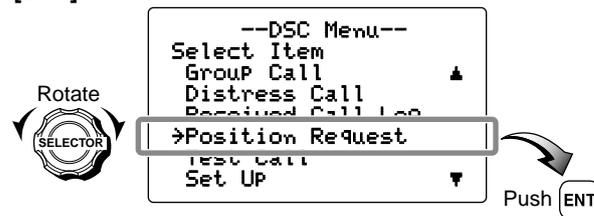

- ② Rotate **[SELECTOR]** to select the desired pre-programmed individual address or "Manual Input," push **[ENT]**.
- The ID code for the Individual call can be set in advance. (p. 19)

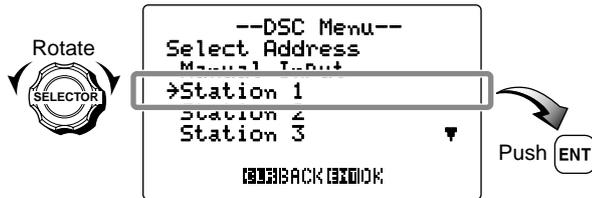

When the pre-programmed address is selected.

- When "Manual Input" is selected, set the 9-digit individual ID you wish to call with the keypad, push **[ENT]**.



- ③ Push **[ENT]** to transmit the Position Request call.
- Emergency channel (Channel 70) is automatically selected.
 - If Channel 70 is busy, the transceiver stands by until the channel becomes clear.

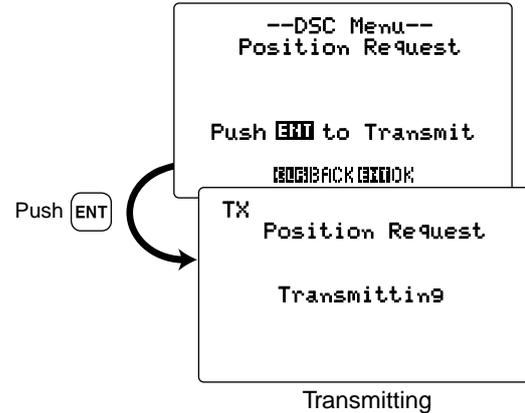

- ④ After the Position Request call has been transmitted, returns to the previous condition (before entering the DSC menu.)

6 DSC OPERATION

◇ Transmitting a Position Reply call

Transmit a Position Reply call when a Position Request is received. (p. 87)

To transmit a “Position Reply”— Quick ACK:

➤ After a Position Request call is received, push [CLR] to stop the alarm, then rotate [SELECTOR] to indicate the received message log. And then, push [ENT].

/// Go to step ⑦ at p. 67 when the transceiver receives the GPS data, or go to step ④ at p. 65 when the transceiver has no position/time data or manual input position/time data.)

To transmit “Position Reply”— Manual ACK:

① Push [MENU] to enter the DSC menu, then rotate [SELECTOR] to select “Position Reply,” push [ENT].

• “Position Reply” is added to the DSC menu after receiving a position request call.

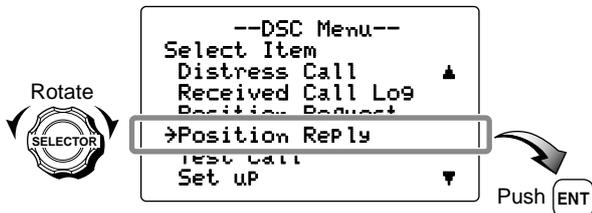

② Rotate [SELECTOR] to select the desired individual address or ID code, push [ENT].



③ The call information appears, push [ENT].

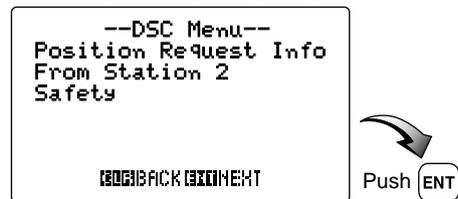

/// When the transceiver receives the GPS data from the connected GPS receiver, the following screens (steps ④ to ⑥) do not appear. Go to step ⑦ at p. 67.

- ④ Input your latitude data directly with the keypad. After inputting, push **[ENT]** to set.
- If the data is not necessary to be changed, push **[ENT]** to skip the input step.
 - Push **[6•MNO]** to input N; North latitude or **[7•PRS]** to input S; South latitude.
 - Rotate **[SELECTOR]** to move the cursor backward or forward.
 - Push **[CE]** to clear the position and time data. (p. 66)
 - Push **[CLR]** to cancel and back to the previous condition.

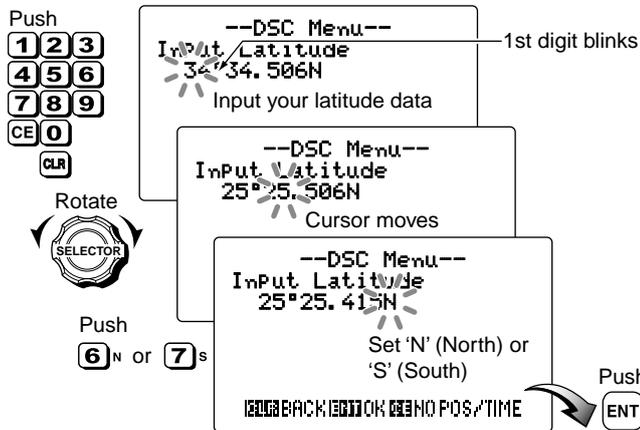

* This illustration shows that the transceiver does not receive the position data from the connected GPS receiver. If the transceiver has no position data, ' _ ' (under bar) is indicated.

- ⑤ Input your longitude data directly with the keypad. After inputting, push **[ENT]** to set.
- If the data is not necessary to be changed, push **[ENT]** to skip the input step.
 - Push **[9•WXY]** to input W; West longitude or **[3•DEF]** to input E; East longitude.
 - Rotate **[SELECTOR]** to move the cursor backward or forward.
 - Push **[CE]** to clear the position and time data. (p. 66)
 - Push **[CLR]** to cancel and back to the previous condition.

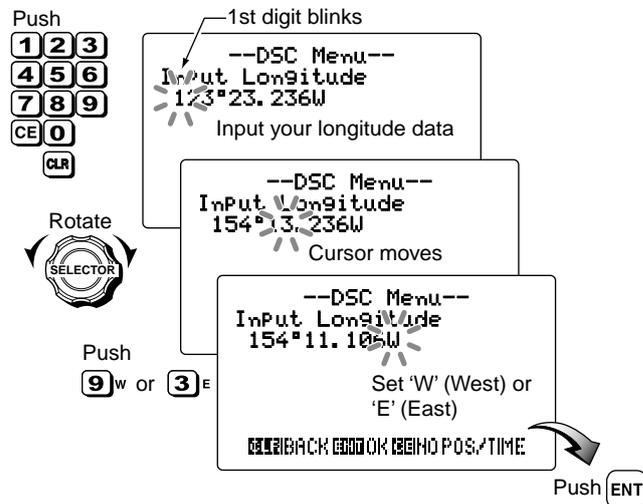

* This illustration shows that the transceiver does not receive the position data from the connected GPS receiver. If the transceiver has no position data, ' _ ' (under bar) is indicated.

6 DSC OPERATION

- ⑥ Input the current UTC time with the keypad. After inputting, push **[ENT]** to set.
- If the data is not necessary to be changed, push **[ENT]** to skip the input step.
 - Rotate **[SELECTOR]** to move the cursor backward or forward.
 - Push **[CE]** to clear the position and time data. (see at right)
 - Push **[CLR]** to cancel and back to the previous screen.

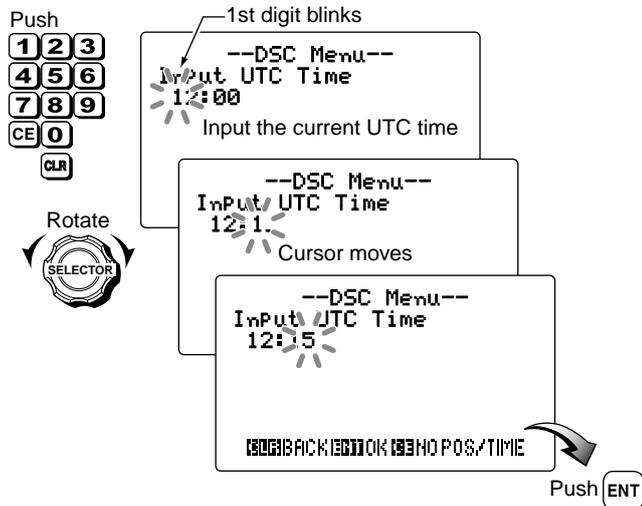

* This illustration shows that the transceiver does not receive the UTC time data from the connected GPS receiver. If the transceiver has no time data, ' _ ' (under bar) is indicated.

NOTE: When no position and time data are input, the following screen appears. Push **[ENT]** to set.

- Push **[CLR]** to cancel and back to the previous screen.

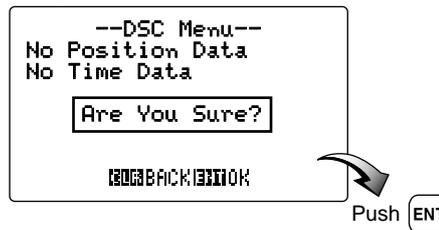

- ⑦ Push **[ENT]** to transmit the Position Reply call to the calling station.
- Your position data is transmitted, when **[ENT]** is pushed.
 - Emergency channel (Channel 70) is automatically selected.
 - If Channel 70 is busy, the transceiver stands by until the channel becomes clear.

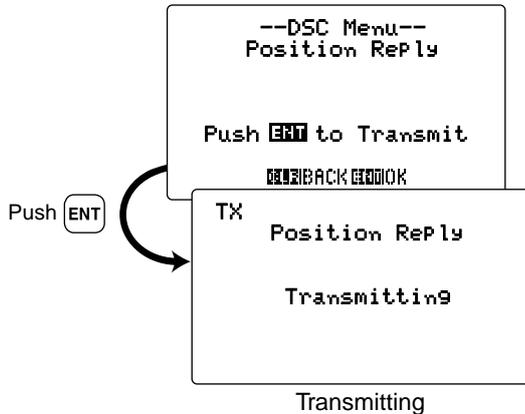

- ⑧ After the Position Reply call has been transmitted, the display automatically returns to the previous condition (before entering the DSC menu.)

◆ Transmitting a Polling Reply call

Transmit a Polling Reply call when a Polling Request is received (p. 89). A Polling Request call enables the calling station to know a specific ship is within communication range, or not.

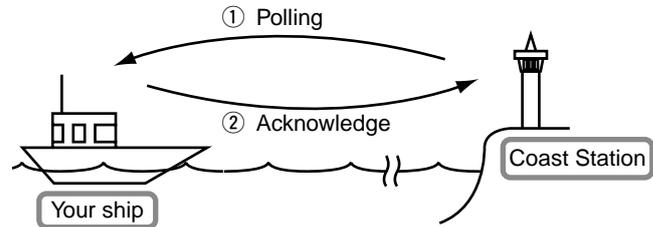

To transmit a “Polling Reply”— Quick ACK:

- After a Polling Request call is received, push **[CLR]** to stop the alarm, then rotate **[SELECTOR]** to indicate the received message log. And then, push **[ENT]**. (Go to step ④ at p. 68.)

☞ Continue to the next page

6 DSC OPERATION

To transmit “Polling Reply”— Manual ACK:

- ① Push **[MENU]** to enter the DSC menu, then rotate **[SELECTOR]** to select “Polling Reply,” push **[ENT]**.
 - “Polling Reply” is added to the DSC menu after receiving a polling request call.

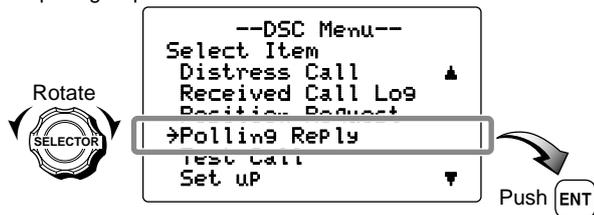

- ② Rotate **[SELECTOR]** to select the desired individual address or ID code, push **[ENT]**.



- ③ The call information appears, push **[ENT]**.



- ④ Push **[ENT]** to transmit the Polling Reply call to the calling station.

- Emergency channel (Channel 70) is automatically selected.
- If Channel 70 is busy, the transceiver stands by until the channel becomes clear.

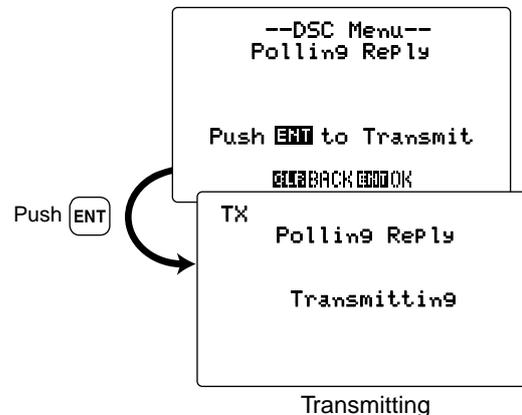

- ⑤ After the Polling Reply call has been transmitted, the display automatically returns to the previous condition (before entering the DSC menu.)

◇ Transmitting a Medical Transports call

The medical transports call informs all ships, by urgency priority, that your ship is carrying a patient in need of a medical treatment.

/// You should set the “Medical Transports” item appearance at DSC Set up menu in advance. (p. 103)

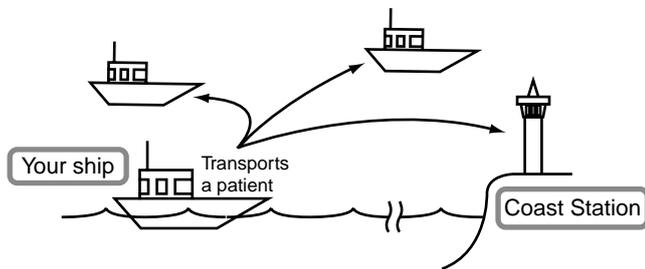

- ① Push **[MENU]** to enter the DSC menu, then rotate **[SELECTOR]** to select “Medical Transports,” push **[ENT]**.

- “Medical Transports” disappears in default.

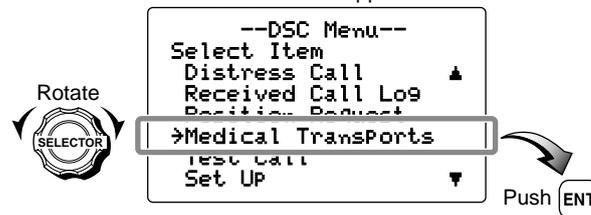

- ② Rotate **[SELECTOR]** to select a desired traffic channel from the list as below, push **[ENT]**.



01	06	11	16	21	26	62	67	73	78	83	88
02	07	12	17	22	27	63	68	74	79	84	
03	08	13	18	23	28	64	69	75	80	85	
04	09	14	19	24	60	65	71	76	81	86	
05	10	15	20	25	61	66	72	77	82	87	

☞ Continue to the next page

6 DSC OPERATION

- ③ Push [ENT] to transmit the Medical Transport call.
- Emergency channel (Channel 70) is automatically selected.
 - If Channel 70 is busy, the transceiver stands by until the channel becomes clear.

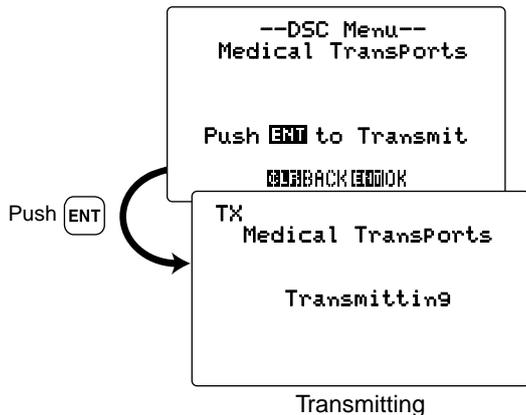

- ④ After the Medical Transport call has been transmitted, the transceiver selects the traffic channel (specified in step ②) automatically.



◇ Transmitting a Neutral Ship call

The Neutral Ship call informs all ships that your ship is a neutral (not a participant) in armed conflict. Be sure to send the call **BEFORE** entering an area of armed conflict.

/// You should set the "Neutral Ship Call" item appearance at
/// DSC Set up menu in advance. (p. 104)

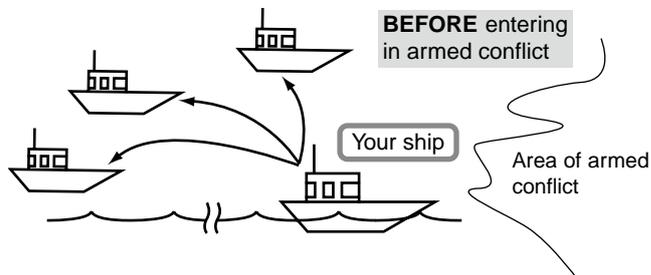

- Push **[MENU]** to enter the DSC menu, then rotate **[SELECTOR]** to select "Neutral Ship," push **[ENT]**.
 - "Neutral Ship" disappears in default.

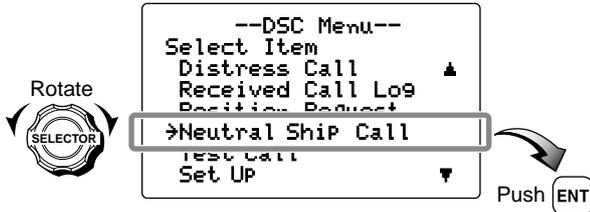

- Rotate **[SELECTOR]** to select a desired traffic channel from the list as below, push **[ENT]**.



01	06	11	16	21	26	62	67	73	78	83	88
02	07	12	17	22	27	63	68	74	79	84	
03	08	13	18	23	28	64	69	75	80	85	
04	09	14	19	24	60	65	71	76	81	86	
05	10	15	20	25	61	66	72	77	82	87	

- Push **[ENT]** to transmit the Neutral Ship call.
 - Emergency channel (Channel 70) is automatically selected.
 - If Channel 70 is busy, the transceiver stands by until the channel becomes clear.

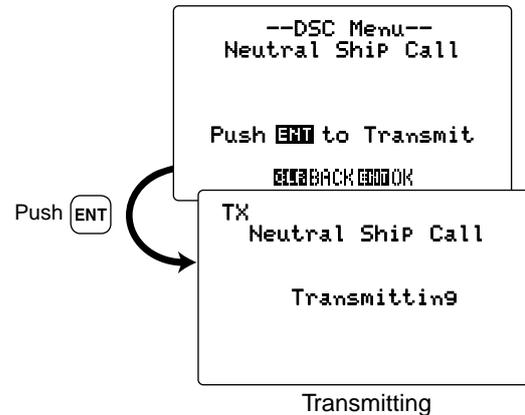

- After the Neutral Ship call has been transmitted, the transceiver selects the traffic channel (specified in step ②) automatically.

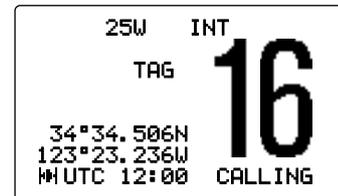

6 DSC OPERATION

◇ Transmitting a Test call

Testing on the exclusive DSC distress and safety calling channels should be avoided as much as possible by using other methods.

Normally the test call would require no further communications between the two stations involved.

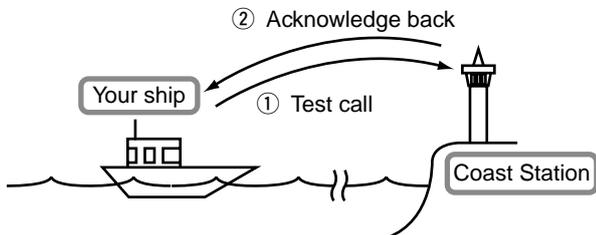

- ① Push **[MENU]** to enter the DSC menu, then rotate **[SELECTOR]** to select "Test Call," push **[ENT]**.

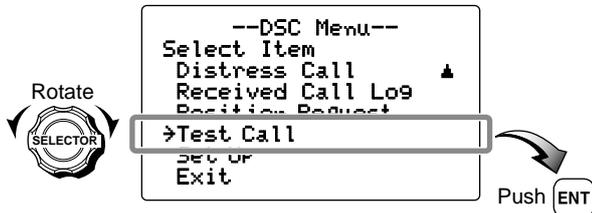

- ② Rotate **[SELECTOR]** to select the desired pre-programmed individual address or "Manual InPut," push **[ENT]**.
- The ID code for the Test call can be set in advance. (p. 19)



When the pre-programmed address is selected.

- When "Manual InPut" is selected, set the 9-digit individual ID you wish to call with the keypad, push **[ENT]**.



- ③ Push [ENT] to transmit the Test call.
- Emergency channel (Channel 70) is automatically selected.
 - If Channel 70 is busy, the transceiver stands by until the channel becomes clear.

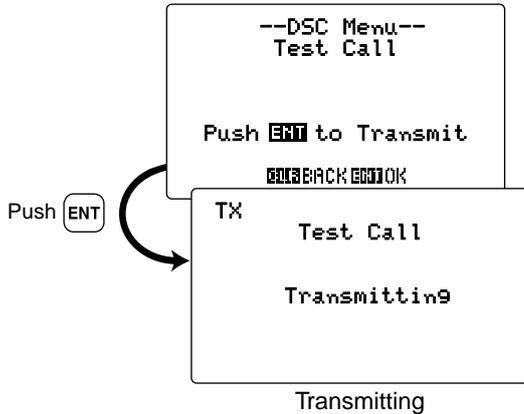

- ④ After the Test call has been transmitted, the transceiver automatically returns to the previous condition (before entering the DSC menu.)

- ⑤ When receiving the acknowledgement call, "Received Test ACK" appears in the display. See p. 91 for details.

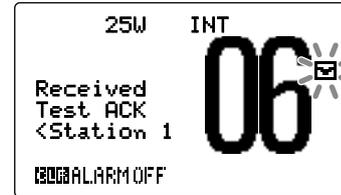

6 DSC OPERATION

◆ Transmitting a Test Acknowledgement call

Transmit a Test Acknowledgement call when a Test call is received (p. 90).

To transmit a “Test Acknowledgement”— Quick ACK:

- After a Test call is received, push [CLR] to stop the alarm, then rotate [SELECTOR] to indicate the received message log. And then, push [ENT]. (Go to step ④ at p. 75.)



To transmit “Test Acknowledgement”— Manual ACK:

- ① Push [MENU] to enter the DSC menu, then rotate [SELECTOR] to select “Test ACK,” push [ENT].

- “Test ACK” is added to the DSC menu after receiving a Test call.



- ② Rotate [SELECTOR] to select the desired individual address or ID code, push [ENT].



- ③ The call information appears, push [ENT].



- ④ Push [ENT] to transmit the Test Acknowledgement call to the calling station.
 - Emergency channel (Channel 70) is automatically selected.
 - If Channel 70 is busy, the transceiver stands by until the channel becomes clear.

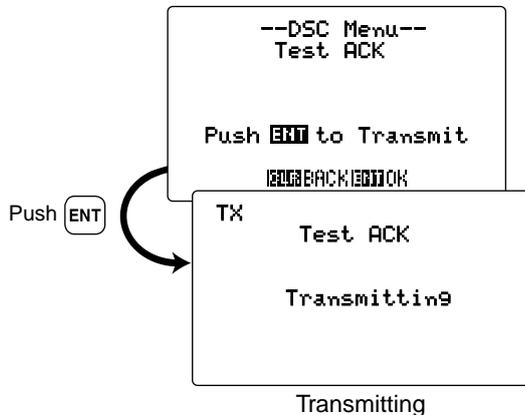

- ⑤ After the Test Acknowledgement call has been transmitted, the transceiver automatically returns to the previous condition (before entering the DSC menu.)

Receiving DSC calls

◇ Receiving a Distress call

- ① While monitoring Channel 70 and a distress call is received:
 - The emergency alarm sounds for 2 minutes after receiving the distress call from a station.
 - Push [CLR] to stop the alarm.
 - "Received Distress" appears in the display, then Channel 16 is automatically selected.
 - "16" blinks in the display.
 - Continue monitoring Channel 16 as a coast station may require assistance.

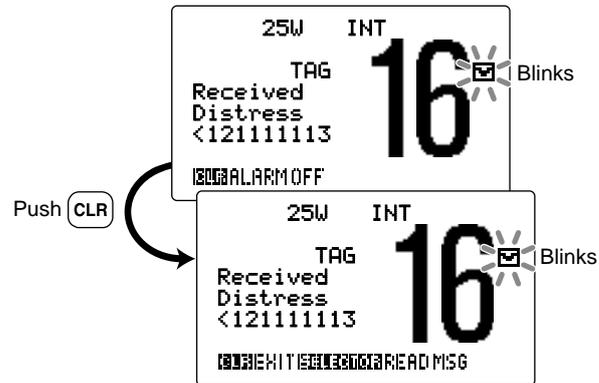

After receiving the Distress call from 121111113.

- "←" means "from."

6 DSC OPERATION

- ② Rotate **[SELECTOR]** to indicate the received message log information.
 - Push **[CLR]** to ignore the call and exit the condition.
- ③ Rotate **[SELECTOR]** to scroll.
 - Push **[CLR]** to cancel and back to the previous screen.
 - Push **[F]**, then push **[8•PRT]** to print out the received message information.

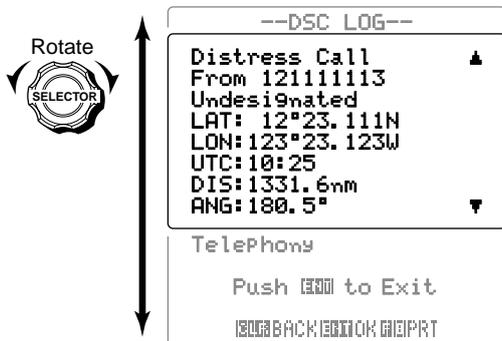

- ④ Push **[ENT]** to return to the normal operation condition.
 - Channel 16 is selected.

IMPORTANT! Distress call reception should stop after one sequence since the coast station should send back an 'acknowledgement' to the ship.

If the distress call continues, the coast station may not be receiving the call. In such cases, you should contact the ship via the phone.

When the ship requires a 'distress relay' call or the ship appears not to reply, you should transmit 'distress relay.' (p. 41)

◇ Receiving a Distress Acknowledgement call

① While monitoring Channel 70 and a Distress acknowledgement call to other ship is received:

- The emergency alarm sounds for 2 minutes.
 - Push [CLR] to stop the alarm.
- "Received DistressACK" appears in the display, then Channel 16 is automatically selected.
- "☑" blinks in the display.

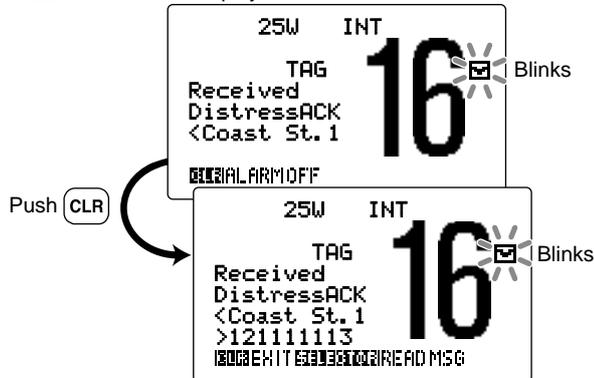

After receiving the Distress Acknowledgement from Coast Station 1.

- "<" means "from."
- ">" means "to."

② Rotate [SELECTOR] to indicate the received message log information.

- Push [CLR] to ignore the call and exit the condition.

③ Rotate [SELECTOR] to scroll.

- Push [CLR] to cancel and back to the previous screen.
- Push [F], then push [8•PRT] to print out the received message information.

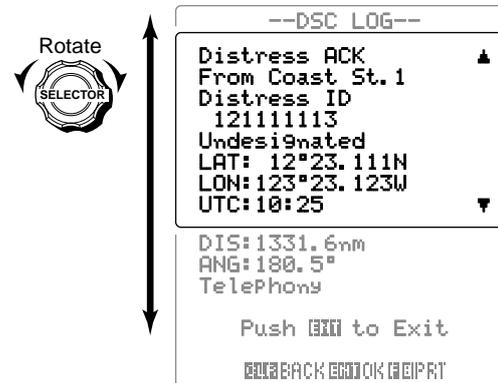

④ Push [ENT] to return to the normal operation condition.

- Channel 16 is selected.

6 DSC OPERATION

◇ Receiving a Distress Cancel

① While monitoring Channel 70 and a Distress Cancel is received:

- The emergency alarm sounds for 2 minutes.
 - Push **[CLR]** to stop the alarm.
- "Received DistressACK" appears in the display, then Channel 16 is automatically selected.
- "☐" blinks in the display.

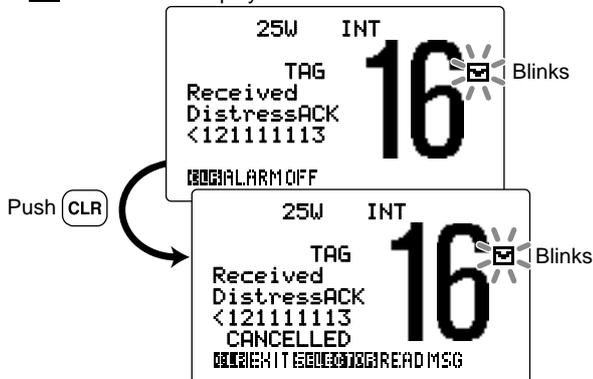

② Rotate **[SELECTOR]** to indicate the received message log information.

- Push **[CLR]** to ignore the call and exit the condition.

③ Rotate **[SELECTOR]** to scroll.

- Push **[CLR]** to cancel and back to the previous screen.
- Push **[F]**, then push **[8•PRT]** to print out the received message information.

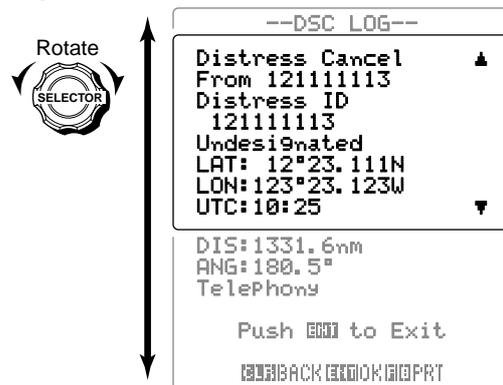

◇ Receiving a Distress Relay call

- ① While monitoring Channel 70 and a Distress Relay call is received:
 - The emergency alarm sounds for 2 minutes.
 - Push [CLR] to stop the alarm.
 - "Received DistressRLY" appears in the display, then Channel 16 is automatically selected.
 - "☑" blinks in the display.

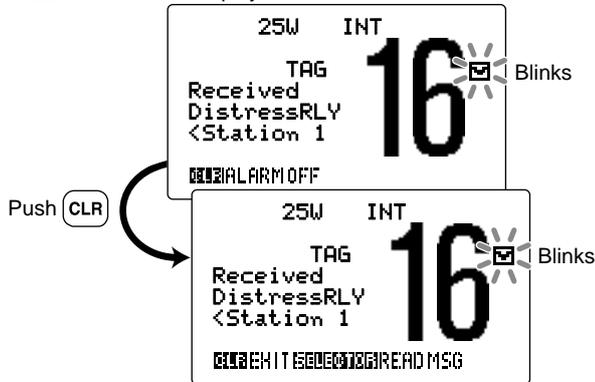

- ② Rotate [SELECTOR] to indicate the received message log.
 - Push [CLR] to ignore the call and exit the condition.

- ③ Rotate [SELECTOR] to indicate the received message log information.
 - Push [CLR] to cancel and back to the previous screen.
 - Push [F], then push [8•PRT] to print out the received message information.

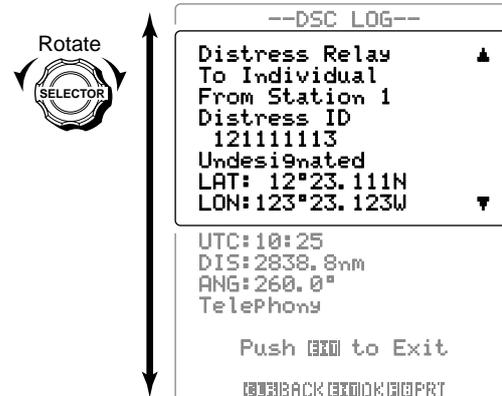

"To All Ships" is indicated instead of "To Individual" when the call type is All Ships.

- ④ Push [ENT] to return to the normal operation condition.
 - Channel 16 is selected.

6 DSC OPERATION

◇ Receiving a Distress Relay Acknowledgement call

① While monitoring Channel 70 and a Distress Relay acknowledgement call is received:

- The emergency alarm sounds for 2 minutes.
 - Push **[CLR]** to stop the alarm.
- "Received Distress RLY ACK" appears in the display, then Channel 16 is automatically selected.
-  blinks in the display.

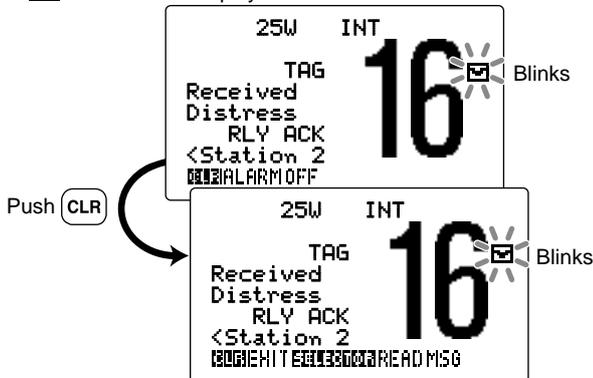

② Rotate **[SELECTOR]** to indicate the received message log.

- Push **[CLR]** to ignore the call and exit the condition.

③ Rotate **[SELECTOR]** to indicate the received message log information.

- Push **[CLR]** to cancel and back to the previous screen.
- Push **[F]**, then push **[8•PRNT]** to print out the received message information.

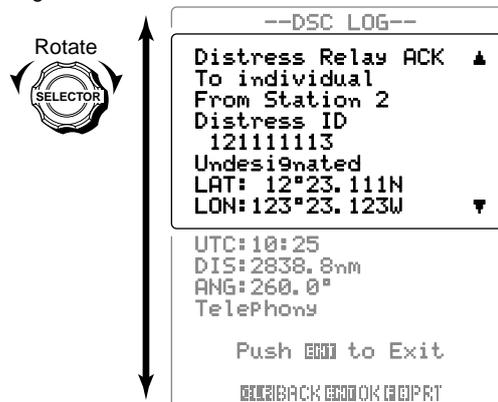

"To All Ships" is indicated instead of "To Individual" when the call type is All Ships.

④ Push **[ENT]** to return to the normal operation condition.

- Channel 16 is selected.

◇ Receiving an All Ships call

- ① While monitoring Channel 70 and an All Ships call is received:
 - The alarm sounds depending on the received category.
 - Push **[CLR]** to stop the alarm.
 - "Received ALL SHIPS" appears in the display.
 - "☑" blinks in the display.

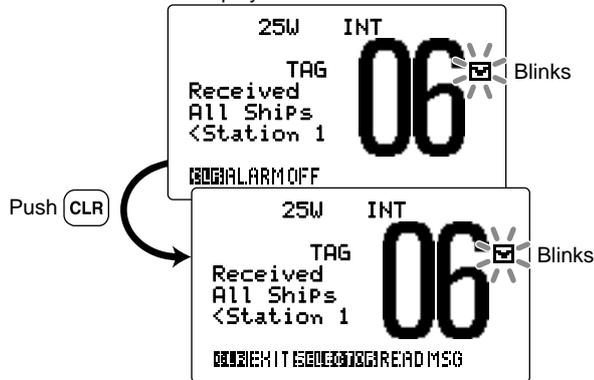

After receiving the All Ships call from Station 1.
 • "<" means "from."

- ② Rotate **[SELECTOR]** to indicate the received message log.
 - Push **[CLR]** to ignore the call and exit the condition.

- ③ The received message log is displayed.
 - Push **[CLR]** to cancel and back to the previous screen.
 - Push **[F]**, then push **[8•PRT]** to print out the received message information.



- ④ Push **[ENT]** to monitor the channel specified by the calling station.

6 DSC OPERATION

◇ Receiving an Individual call

① While monitoring Channel 70 and an Individual call is received:

- The alarm sounds depending on the received category.
 - Push **[CLR]** to stop the alarm.
- "Received Individual" appears in the display.
- "☐" blinks in the display.

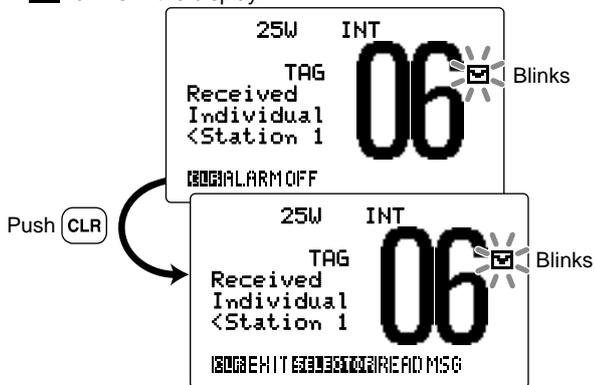

② Rotate **[SELECTOR]** to indicate the received message log.

- Push **[CLR]** to ignore the call and exit the condition.

③ The received message log is displayed.

- Push **[CLR]** to cancel and back to the previous screen.
- Push **[F]**, then push **[8•PRT]** to print out the received message information.

```
--DSC LOG--  
Individual Call  
From Station 1  
Routine  
TelePhony  
CH08  
  
☐☐BACK☐☐REPLY☐PRT
```

④ Push **[ENT]** to reply the call and change the channel specified by the calling station for voice communication. (p. 54)

◇ Receiving an Individual Acknowledgement call

When receiving "Able to Comply":

- ① While monitoring Channel 70 and an Individual acknowledgement call "Able to comply" is received:
 - The alarm sounds depending on the received category.
 - Push [CLR] to stop the alarm.
 - "Received Able ACK" appears in the display.
 - "[]" blinks in the display.

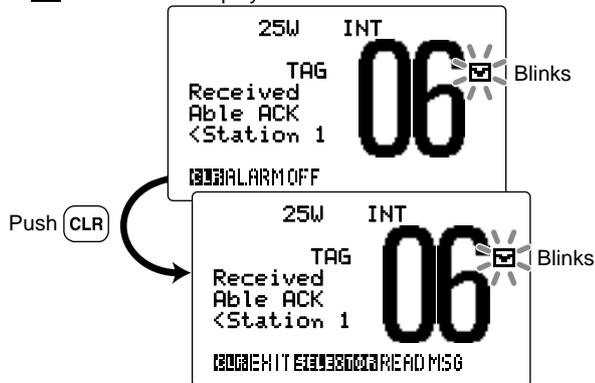

After receiving the "Able to comply" from Station 1.

- "<" means "from."

- ② Rotate [SELECTOR] to indicate the received message log.
 - Push [CLR] to ignore the call and exit the condition.

- ③ The received message log is displayed.
 - Push [CLR] to cancel and back to the previous screen.
 - Push [F], then push [8•PRT] to print out the received message information.

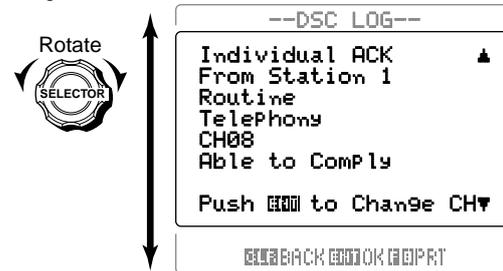

- ④ Push [ENT] to change the channel (specified by you when the individual call is transmitted) for voice communication.

6 DSC OPERATION

When receiving "Propose New Channel":

- While monitoring Channel 70 and an Individual acknowledgement call "Able to comply" is received:
 - The alarm sounds depending on the received category.
 - Push **[CLR]** to stop the alarm.
 - "Received Able ACK" appears in the display.
 - "" blinks in the display.

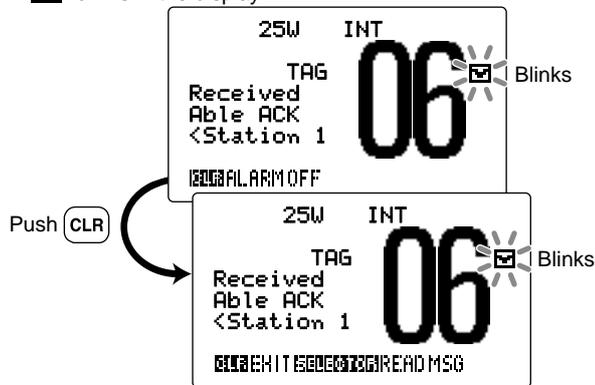

After receiving the "Able to comply" from Station 1.
 • "<" means "from."

- Rotate **[SELECTOR]** to indicate the received message log.
 - Push **[CLR]** to ignore the call and exit the condition.

- The received message log is displayed.
 - Push **[CLR]** to cancel and back to the previous screen.
 - Push **[F]**, then push **[8•PRT]** to print out the received message information.

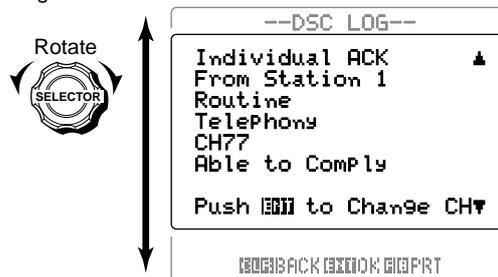

- Push **[ENT]** to reply the call and change the channel proposed by the called station for voice communication.

When receiving “Unable to Comply”:

- ① While monitoring Channel 70 and an Individual acknowledgement call “Unable to comply” is received:
 - The alarm sounds depending on the received category.
 - Push [CLR] to stop the alarm.
 - “Received Unable ACK” appears in the display.
 - “[]” blinks in the display.

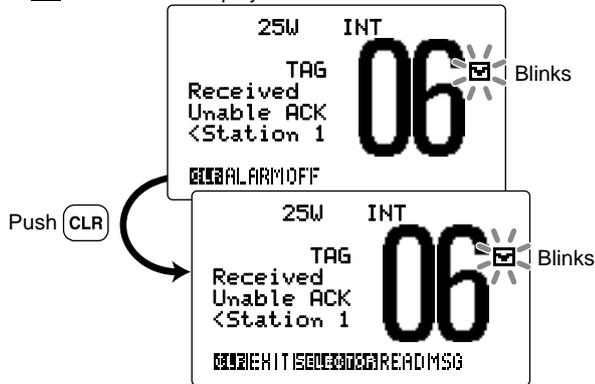

After receiving the “Unable to comply” from Station 1.
 • “<” means “from.”

- ② Rotate [SELECTOR] to indicate the received message log.
 - Push [CLR] to ignore the call and exit the condition.

- ③ The received message log is displayed.
 - Push [CLR] to cancel and back to the previous screen.
 - Push [F], then push [8•PRT] to print out the received message information.

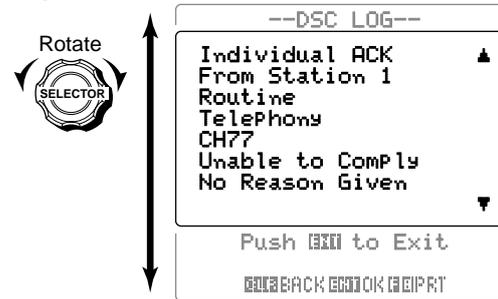

- ④ Push [ENT] to return to the normal operation condition.

6 DSC OPERATION

◇ Receiving a Group call

① While monitoring Channel 70 and a Group call is received:

- The alarm sounds depending on the received category.
 - Push **[CLR]** to stop the alarm.
- "Received Group" appears in the display.
-  blinks in the display.

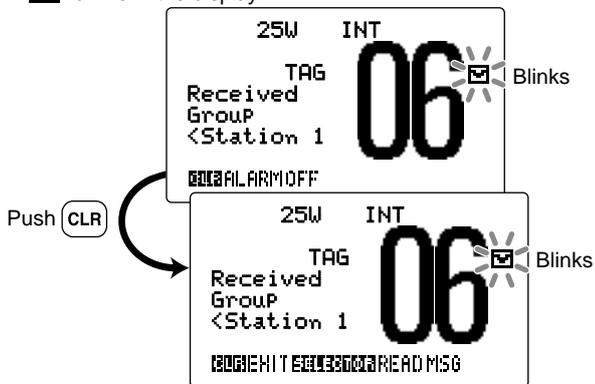

After receiving the Group call from Station 1.

- "<" means "from."

② Rotate **[SELECTOR]** to indicate the received message log.

- Push **[CLR]** to ignore the call.

③ The received message log is displayed.

- Push **[CLR]** to cancel and back to the previous screen.
- Push **[F]**, then push **[8•PRT]** to print out the received message information.

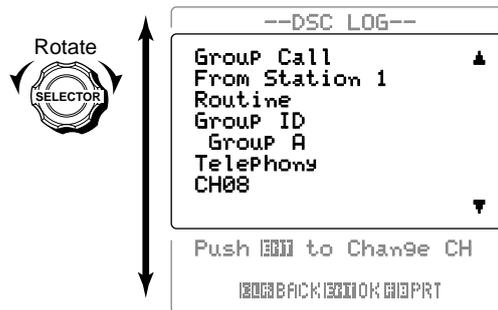

④ Push **[ENT]** to change the channel specified by the calling station for listening to an announcement.

◇ Receiving a Position Request call

① While monitoring Channel 70 and a Position Request call is received:

- The alarm sounds depending on the received category.
 - Push [CLR] to stop the alarm.
- "Received POS Request" appears in the display.

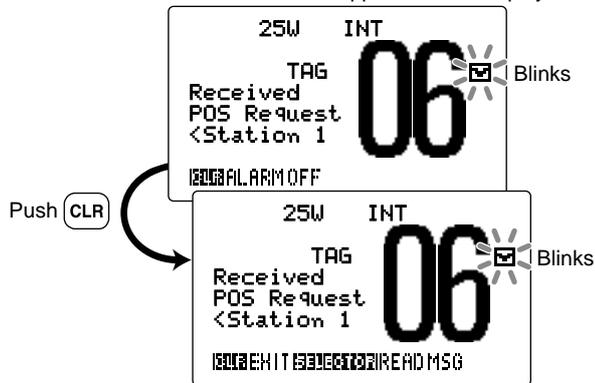

After receiving the Position Request call from Station 1.
 • "<" means "from."

② Rotate [SELECTOR] to indicate the received message log.

- Push [CLR] to ignore the call.

③ The received message log is displayed.

- Push [CLR] to cancel and back to the previous screen.
- Push [F], then push [8•PRT] to print out the received message information.



④ Push [ENT] to transmit the Position Reply call. (p. 64)

• Position Automatic Acknowledgement

When the position automatic acknowledgement function is set to ON (p. 100), the transceiver automatically transmits a Position Reply call after a Position Request call is received.

6 DSC OPERATION

◇ Receiving a Position Reply call

① While monitoring Channel 70 and a Position Reply call is received:

- The alarm sounds depending on the received category.
 - Push **[CLR]** to stop the alarm.
- "Received POS Reply" appears in the display.

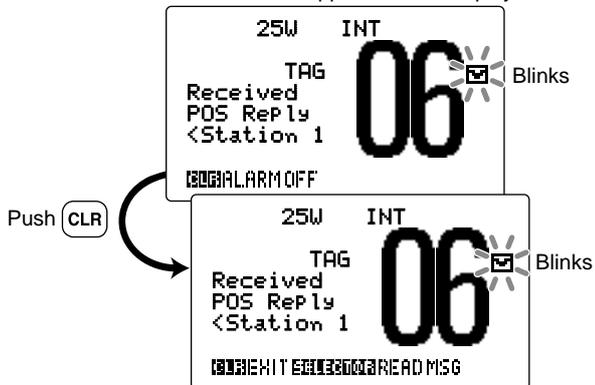

After receiving the Position Reply call from Station 1.
• "<" means "from."

② Rotate **[SELECTOR]** to indicate the received message log.
• Push **[CLR]** to exit the condition.

③ Rotate **[SELECTOR]** to scroll the indicated information.
• Push **[CLR]** to cancel and back to the previous screen.
• Push **[F]**, then push **[8•PRT]** to print out the received message information.

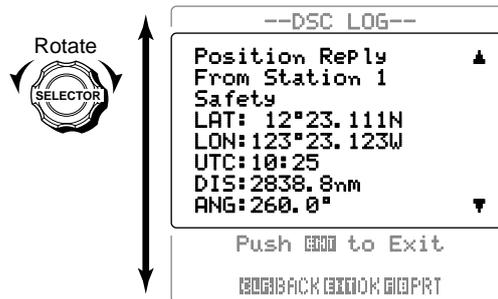

④ Push **[ENT]** to return to the normal operation condition.

◇ Receiving a Polling Request call

① While monitoring Channel 70 and a Polling Request call is received:

- The alarm sounds depending on the received category.
 - Push **[CLR]** to stop the alarm.
- "Received POLL REQ" appears in the display.

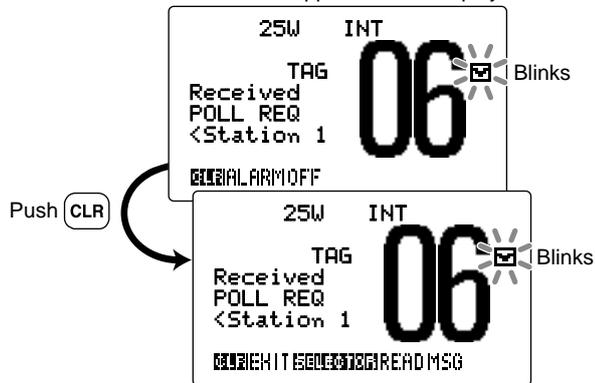

After receiving the Polling Request call from Station 1.
 • "←" means "from."

② Rotate **[SELECTOR]** to indicate the received message log.

- Push **[CLR]** to ignore the call.

③ The received message log is displayed.

- Push **[CLR]** to cancel and back to the previous screen.
- Push **[F]**, then push **[8•PRT]** to print out the received message information.



④ Push **[ENT]** to transmit the Polling Reply call. (p. 67)

• Position Automatic Acknowledgement

When the position automatic acknowledgement function is set to ON (p. 100), the transceiver automatically transmits a Polling Reply call after a Polling Request call is received.

6 DSC OPERATION

◇ Receiving a Test call

① While monitoring Channel 70 and a Test call is received:

- The alarm sounds depending on the received category.
 - Push **[CLR]** to stop the alarm.
- "Received Test Call" appears in the display.

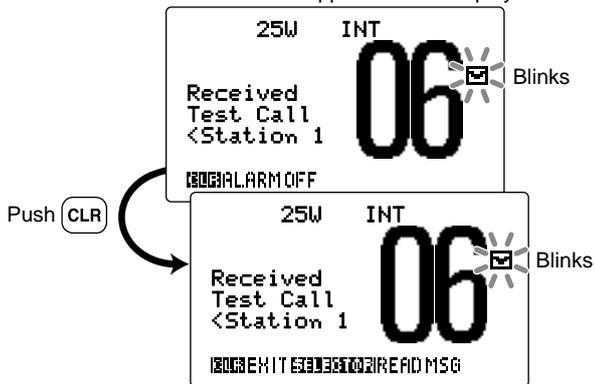

After receiving the Test call from Station 1.

- "<" means "from."

② Rotate **[SELECTOR]** to indicate the received message log.

- Push **[CLR]** to exit the condition.

③ The received message log is displayed.

- Push **[CLR]** to cancel and back to the previous screen.
- Push **[F]**, then push **[8•PRT]** to print out the received message information.



④ Push **[ENT]** to transmit the Test Acknowledgement call. (p. 74)

• Position Automatic Acknowledgement

When the position automatic acknowledgement function is set to ON (p. 100), the transceiver automatically transmits a Test Acknowledgement call after a Test call is received.

◇ Receiving a Test Acknowledgement call

① While monitoring Channel 70 and a Test Acknowledgement call is received:

- The alarm sounds depending on the received category.
 - Push [CLR] to stop the alarm.
- "Received Test ACK" appears in the display.

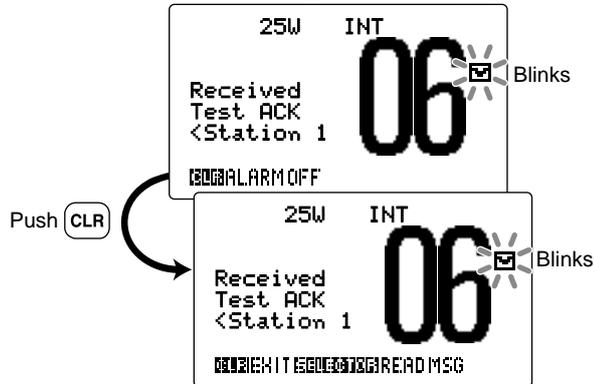

After receiving the Test Acknowledgement from Station 1.
 • "<" means "from."

② Rotate [SELECTOR] to indicate the received message log.

- Push [CLR] to exit the condition.

③ The received message log is displayed.

- Push [CLR] to cancel and back to the previous screen.
- Push [F], then push [8•PRT] to print out the received message information.



④ Push [ENT] to return to the normal operation condition.

Received messages

The transceiver automatically stores up to 20 distress messages and 20 other messages.

The stored messages are automatically deleted after 48 hours has passed from storing.

The messages can be used as an assistance to the logbook.

- "E" indicator blinks when the unread message is stored in the Call Log memory during normal operation condition.

◇ Distress message

- ① Push [MENU] to enter the DSC menu, then rotate [SELECTOR] to select "Received Call Log," push [ENT].

- Or, push [F], then push [9•LOG] to indicate "Select Message" screen as step ②.

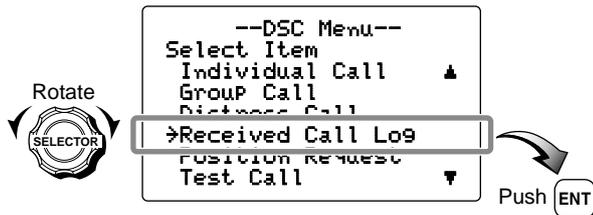

- ② Rotate [SELECTOR] to select "Distress."

- The received messages are stored in "Distress" in DSC menu if its category or format specifier is 'Distress.'



- ③ Rotate [SELECTOR] to select the desired message, push [ENT].

- Messages which are blinking have not been read yet. The unread message blinks.



- ④ Rotate [SELECTOR] to scroll the selected message.
- The stored message has various information depending on the type of Distress call.
 - Push [ENT] to select the channel 16.
 - Push [CLR] to cancel and back to the previous screen.
 - Push [CE] to delete the displayed log and returns to "Select Message" screen.
 - Push [E], then push [8•PRT] to print out the received message information.

In case of the Distress call

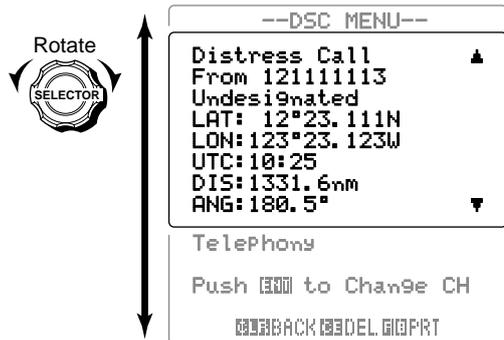

In case of the Distress Acknowledgement call

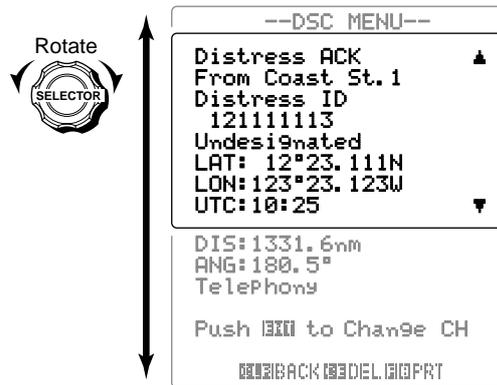

6 DSC OPERATION

In case of the Distress Cancel

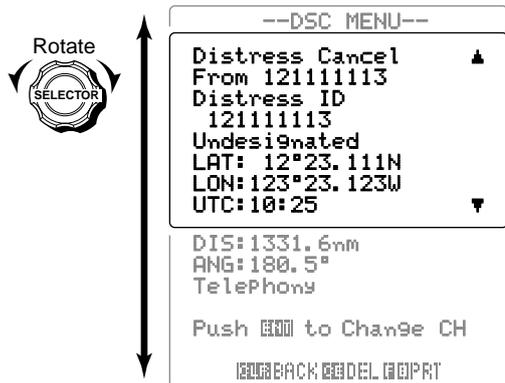

In case of the Distress Relay Acknowledgement call

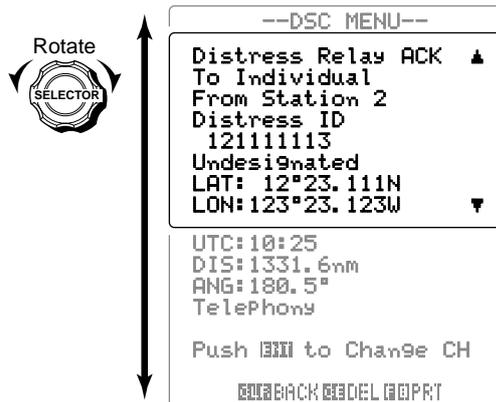

In case of the Distress Relay call

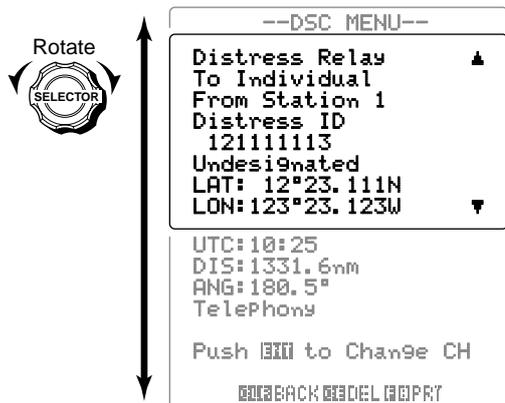

When [CE] is pushed, the following screen appears. Push [ENT] to delete the selected log data.



◆ Other messages

- 1 Push [MENU] to enter the DSC menu, then rotate [SELECTOR] to select "Received Call Log," push [ENT].
 - Or, push [F], then push [9•LOG] to indicate "Select Message" screen as step ②.

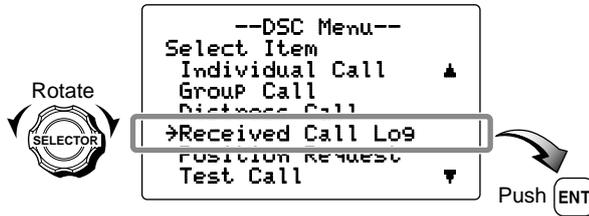

- 2 Rotate [SELECTOR] to select "Others."



- 3 Rotate [SELECTOR] to scroll to the desired message, push [ENT].

- Messages which are blinking have not read yet.



The unread message blinks.

- 4 Rotate [SELECTOR] to scroll the message.

- The stored message has various information depending on the type of DSC call.
- Push [CLR] to cancel and back to the previous screen.
- Push [CE] to delete the displayed log and returns to "Select Message" screen.
- Push [F], then push [8•PRT] to print out the received message information.

In case of the Individual call



- Push [ENT] to reply the call. (p. 54)

6 DSC OPERATION

In case of the Individual Acknowledgement call 'Able to Comply'

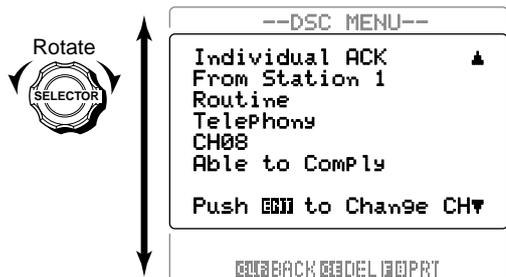

- Push [ENT] to change the channel specified by you or proposed by the called station.

In case of the All Ships call



- Push [ENT] to change the channel, specified by the calling station.

In case of the Individual Acknowledgement call 'Unable to Comply'

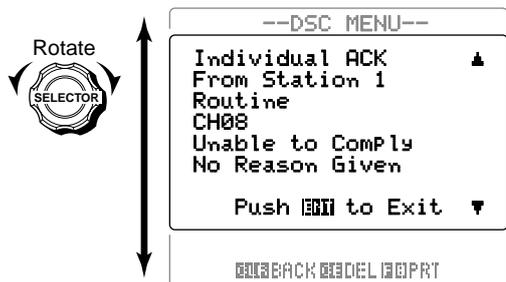

- Push [ENT] to exit the condition.

In case of the Group call

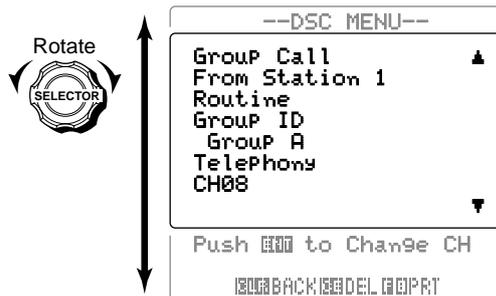

- Push [ENT] to change the channel, specified by the calling station.

In case of the Position Request call

```

--DSC MENU--
Position Request
From Station 1
Safety

[BACK][REPLY]
[DEL][PRT]
    
```

- Push [ENT] to reply the call. (p. 64)

In case of the Polling Request call

```

--DSC MENU--
Polling Request
From Station 1
Routine

[BACK][REPLY]
[DEL][PRT]
    
```

- Push [ENT] to reply the call. (p. 67)

In case of the Position Reply call



```

--DSC MENU--
Position Reply ▲
From Station 1
Safety
LAT: 12°23.111N
LON: 123°23.123W
UTC: 10:25
DIS: 1331.6nm
ANG: 180.5° ▼

Push [EXIT] to Exit

[BACK][REPLY]
[DEL][PRT]
    
```

↑

↓

- Push [ENT] to exit the condition.

In case of the Test call

```

--DSC MENU--
Test Call
From Station 1
Safety

[BACK][REPLY]
[DEL][PRT]
    
```

- Push [ENT] to reply the call. (p. 74)

6 DSC OPERATION

In case of the Test Acknowledgement call

```
    --DSC MENU--  
Test ACK  
From Station 1  
Safety  
  
    Push [ENT] to Exit  
  
    [BACK] [DEL] [PRT]
```

- Push [ENT] to exit the condition.

When [CE] is pushed, the following screen appears. Push [ENT] to delete the selected log data.

```
    --DSC Menu--  
Log Deletion  
  
    [Are You Sure?]  
  
    Push [ENT] to Delete  
  
    [BACK] [OK]
```

■ DSC Set mode

◇ Programming Individual ID/Group ID

(See pgs. 19, 23)

◇ Deleting Individual ID/Group ID

(See pgs. 22, 26)

◇ Printing out the DSC memory contents

The automatic print out capability when a DSC call is received is available.

The received DSC call contents can be printed out when a printer (IBM® centronics or compatible) is connected to the transceiver. (p. 109)

- ① Push **[MENU]** to enter the DSC menu, then rotate **[SELECTOR]** to select "Set UP," push **[ENT]**.

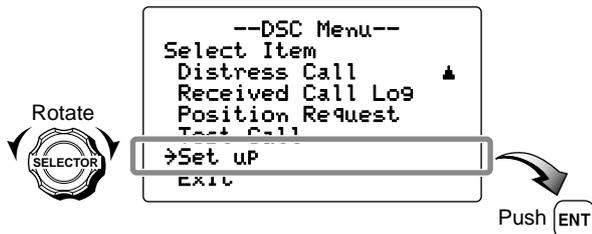

- ② Rotate **[SELECTOR]** to select "Auto Print," push **[ENT]**.

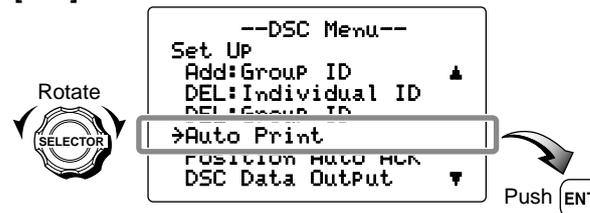

- ③ Rotate **[SELECTOR]** to select the automatic print out function ON or OFF.



- ④ Push **[ENT]** to set and return to the DSC Set up menu.
 • Push **[CLR]** to cancel and back to the previous screen.
- ⑤ Rotate **[SELECTOR]** to select "Exit," push **[ENT]** to return to DSC menu.
 • Pushing **[CLR]** also returns to DSC menu.
- ⑥ Repeat again to return to the normal operation condition.

6 DSC OPERATION

◇ Position Automatic Acknowledgement

This item sets the position automatic acknowledgement function to ON or OFF.

When a position request, polling request or test call is received, the transceiver automatically transmits a position reply call, polling reply call, or test acknowledgement call, respectively.

- ① Push **[MENU]** to enter the DSC menu, then rotate **[SELECTOR]** to select "Set up," push **[ENT]**.

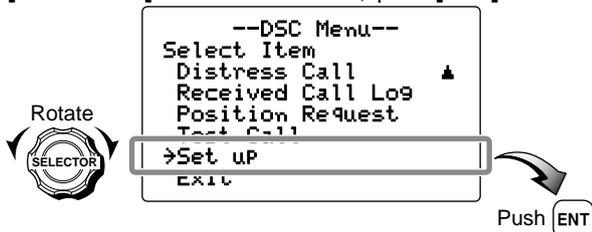

- ② Rotate **[SELECTOR]** to select "Position Auto ACK," push **[ENT]**.



- ③ Rotate **[SELECTOR]** to select the position automatic acknowledgement function ON or OFF.



- ④ Push **[ENT]** to set and return to the DSC Set up menu.
 - Push **[CLR]** to cancel and back to the previous screen.
- ⑤ Rotate **[SELECTOR]** to select "Exit," push **[ENT]** to return to DSC menu.
 - Pushing **[CLR]** also returns to DSC menu.
- ⑥ Repeat again to return to the normal operation condition.

◇ DSC Data Output

Select a DSC Data Output function from List Station, All Station or OFF.

When receiving position acknowledgment or DSC call including the position information, the transceiver outputs it to the external equipment via the GPS RECEIVER/EXTERNAL SPEAKER connector to indicate the received position data on the hydrographic chart via the connected plotter, etc.

- ① Push **[MENU]** to enter the DSC menu, then rotate **[SELECTOR]** to select "Set up," push **[ENT]**.

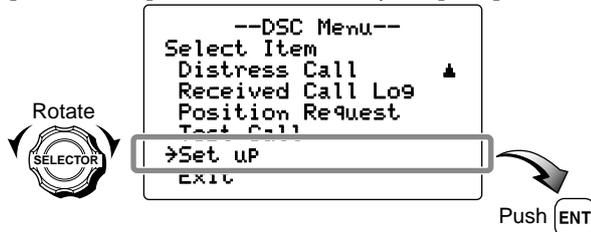

- ② Rotate **[SELECTOR]** to select "DSC Data Output," push **[ENT]**.

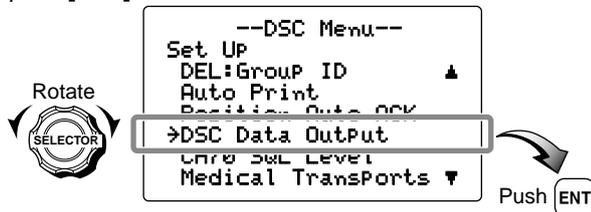

- ③ Rotate **[SELECTOR]** to select the DSC Data Output function from List Station, All Station or OFF.

- List Station : Outputs the position data from the specified stations listed in the DSC individual ID screen.
- All Station : Outputs the position data from all stations.
- OFF : Outputs no position data to external equipment.



- ④ Push **[ENT]** to set and return to the DSC Set up menu.
 - Push **[CLR]** to cancel and back to the previous screen.
- ⑤ Rotate **[SELECTOR]** to select "Exit," push **[ENT]** to return to DSC menu.
 - Pushing **[CLR]** also returns to DSC menu.
- ⑥ Repeat again to return to the normal operation condition.

6 DSC OPERATION

◇ Squelch Level Setting for Channel 70 Receiver

Set the desired squelch level independently for the channel 70 receiver.

- ① Push **[MENU]** to enter the DSC menu, then rotate **[SELECTOR]** to select "Set up," push **[ENT]**.

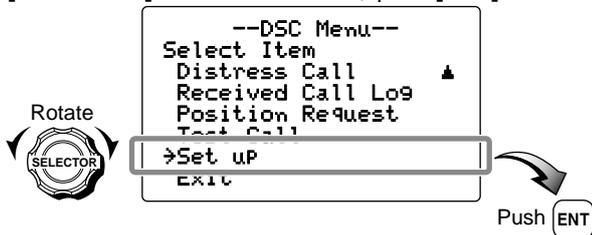

- ② Rotate **[SELECTOR]** to select "CH70 SQL Level," push **[ENT]**.



- ③ Rotate **[SELECTOR]** to set the desired squelch level on channel 70 from Very High Noise, High Noise or Normal Condition.

- Very High Noise : Very high noise is emitted.
- High Noise : High noise is emitted.
- Normal Condition : The squelch level is normal condition.

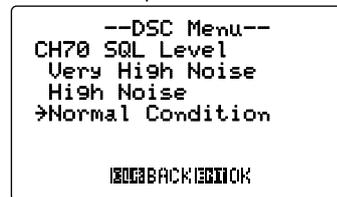

- ④ Push **[ENT]** to set and return to the DSC Set up menu.
- Push **[CLR]** to cancel and back to the previous screen.
- ⑤ Rotate **[SELECTOR]** to select "Exit," push **[ENT]** to return to DSC menu.
- Pushing **[CLR]** also returns to DSC menu.
- ⑥ Repeat again to return to the normal operation condition.

◇ Medical Transports item Appearance in DSC Set up menu

The “Medical Transports” item can be set to appear or disappear in DSC Set up menu.

- ① Push **[MENU]** to enter the DSC menu, then rotate **[SELECTOR]** to select “Set up,” push **[ENT]**.
 - “Medical Transports” and “Neutral Ship Call” disappear in default.

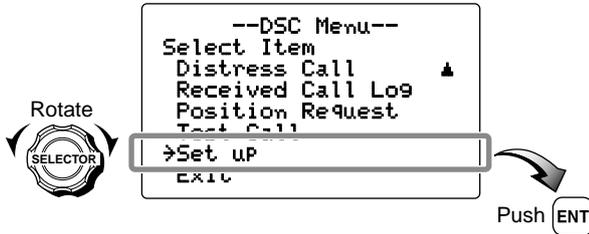

- ② Rotate **[SELECTOR]** to select “Medical Transports,” push **[ENT]**.



- ③ Rotate **[SELECTOR]** to select the item appearance in DSC Set up menu.



- ④ Push **[ENT]** to set and return to the DSC Set up menu.
 - Push **[CLR]** to cancel and back to the previous screen.
- ⑤ Rotate **[SELECTOR]** to select “Exit,” push **[ENT]** to return to DSC menu.
 - Pushing **[CLR]** also returns to DSC menu.
- ⑥ Repeat again to return to the normal operation condition.

6 DSC OPERATION

◆ Neutral Ship Call item Appearance in DSC Set up menu

The "Neutral Ship Call" item can be set to appear or disappear in DSC Set up menu.

- ① Push **[MENU]** to enter the DSC menu, then rotate **[SELECTOR]** to select "Set up," push **[ENT]**.
 - "Medical Transports" and "Neutral Ship Call" disappear in default.

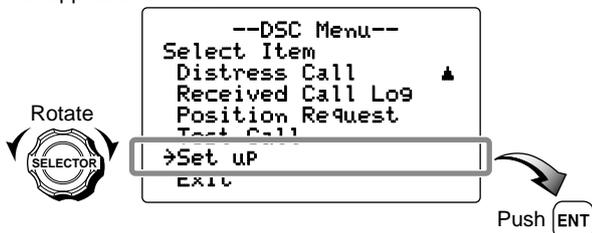

- ② Rotate **[SELECTOR]** to select "Neutral Ship Call," push **[ENT]**.



- ③ Rotate **[SELECTOR]** to select each item appearance in DSC Set up menu.



- ④ Push **[ENT]** to set and return to the DSC Set up menu.
 - Push **[CLR]** to cancel and back to the previous screen.
- ⑤ Rotate **[SELECTOR]** to select "Exit," push **[ENT]** to return to DSC menu.
 - Pushing **[CLR]** also returns to DSC menu.
- ⑥ Repeat again to return to the normal operation condition.

◇ Self Check Testing

According to regulations, the IC-GM651 has a self testing capability to check the internal AFSK encoder and decoder circuits without signal transmission via the transceiver.

- ① Push **[MENU]** to enter the DSC menu, then rotate **[SELECTOR]** to select "Set uP," push **[ENT]**.

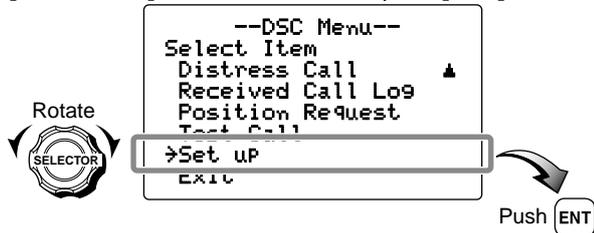

- ② Rotate **[SELECTOR]** to select "Self Check Test," push **[ENT]**.

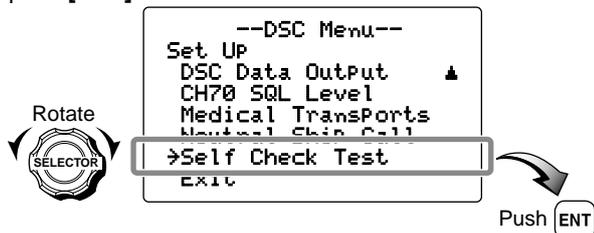

- ③ Push **[ENT]** to start the Self Check Testing.
- ④ The result of the Self Check Testing is indicated.
 - When the result is "NG," the transceiver should be repaired.
 - Push **[CLR]** to cancel and back to the previous screen.
 - Push **[ENT]** to restart the Self Check Test.



When the result is "OK"

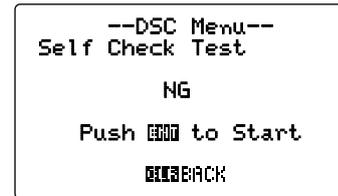

When the result is "NG"

- ⑤ Rotate **[SELECTOR]** to select "Exit," push **[ENT]** to return to DSC menu.
 - Pushing **[CLR]** also returns to DSC menu.
- ⑥ Repeat again to return to the normal operation condition.

■ Set mode programming

Set mode is used to change the conditions of the transceiver's functions: Scan type, Scan resume timer, Beep tone, Internal speaker, Display contrast, Microphone type and Cursor movement.

/// Available functions may differ depending on dealer setting.

/// **NOTE:** The transceiver automatically returns to the normal operation condition when no operation is performed for 1 minutes in Set mode.

- ① While pushing and holding **[16•C]**, push **[POWER]** to enter Set mode.
 - Turn power OFF in advance.
- ② After the display appears, release **[16•C]**.
- ③ Rotate **[SELECTOR]** to select the desired item, push **[ENT]**.
- ④ Rotate **[SELECTOR]** to select the desired condition of the item, push **[ENT]** to set.
- ⑤ Push **[CLR]**, or rotate **[SELECTOR]** to select "Exit" then push **[ENT]** to exit Set mode and returns to normal condition.

• SET MODE CONSTRUCTION

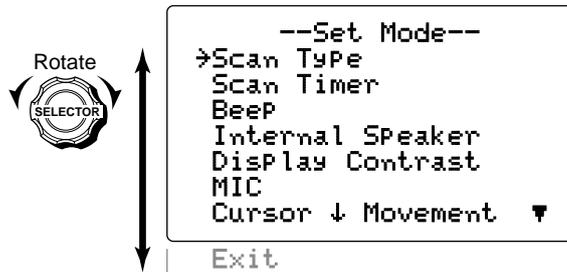

■ Set mode items

◇ Scan type

The transceiver has 2 scan types: normal scan and priority scan. Normal scan searches all TAG channels in the selected channel group. Priority scan searches all TAG channels in sequence while monitoring Channel 16.

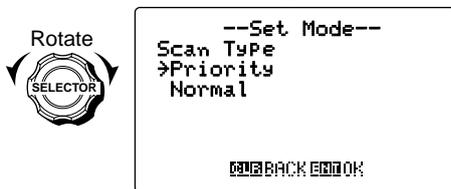

(Default: Priority)

◇ Scan resume timer

The scan resume timer can be selected as a pause (OFF) or timer scan (ON).

OFF : The scan pauses until the signal disappears and then resumes 2.5 sec. later.

ON : The scan pauses on a channel which receives a signal, then resumes after 5 sec. has passed.



(Default: OFF)

◇ Beep tone

You can select silent operation by turning beep tones OFF, or you can have confirmation beeps sound at the push of a key and rotating a selector by turning beep tones ON.



(Default: ON)

◇ Internal speaker

When an external speaker is connected and the transceiver's internal speaker is not required, the speaker of the transceiver and the connected microphone can be deactivated.



(Default: ON)

7 SET MODE

◇ Display contrast

This item adjusts the contrast of the LCD in 8 steps.

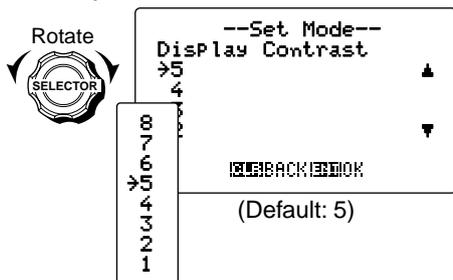

◇ Microphone type

You can select the usable microphone type from Hand microphone and Handset.



◇ Cursor ↓ (Downward) movement

You can select the direction of [SELECTOR] rotation from CW (clockwise) or CCW (counter-clockwise) to move the cursor downward.

Turn Selector CW : Rotate [SELECTOR] clockwise for the cursor downward.

- Rotate [SELECTOR] counter-clockwise for the cursor upward.

Turn Selector CCW : Rotate [SELECTOR] counter-clockwise for the cursor downward.

- Rotate [SELECTOR] clockwise for the cursor upward.

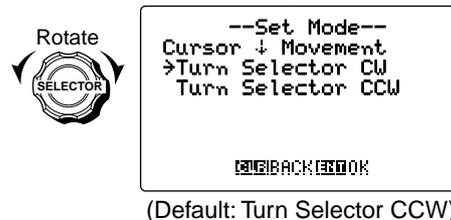

■ Connections

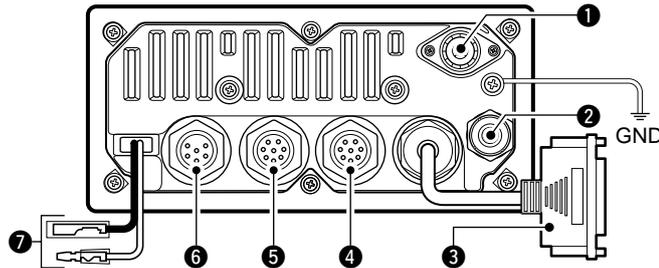

1 ANTENNA CONNECTOR

Connects a marine VHF antenna with a PL-259 connector to the transceiver.

CAUTION: Transmitting without an antenna will damage the transceiver.

2 ANTENNA CONNECTOR (for receiving on Channel 70)

Connects a marine VHF antenna with a PL-259 connector to the transceiver.

3 D-SUB 25-PIN (for a printer connection)

Connects a printer (IBM® centronics or compatible) to the transceiver.

4 HANDSET CONNECTOR

Connect the optional handset only.

CAUTION: NEVER connect the optional hand microphone here. They may cause damage to the transceiver.

5 VDR/CLONE CONNECTORS

Connects a voice recorder.



Transceiver's rear panel view

6 GPS RECEIVER/EXTERNAL SPEAKER CONNECTOR

Connects a GPS receiver to DSC Data IN (-)/(+) for position and time indications.

- Input level: Less than 2 mA (when 2 V applied; as a listener)
- An IEC61162-1: 2000 (sentence formatters RMC, GGA, GNS, GLL) compatible GPS receiver is required. Ask your dealer about suitable GPS receivers.



Transceiver's rear panel view

Connects a navigation equipment.

- Output level: 40 mA max. (as a talker)
- IEC61162-1: 2000 (sentence formatters DSC, DSE) compatible for plotting received other ships position data.

Connects an external speaker.

- Lead: Thicker than 0.75 sq mm, Length: Shorter than 1.5 m are recommended.

8 CONNECTIONS AND MAINTENANCE

7 DC POWER CONNECTOR

Connects the PS-250 with the supplied DC power cable.
(p. 112)

CAUTION:

- IC-GM651 should be connected to the DC power supply through the PS-250, sold by the set with the IC-GM651, when it is operated.
- After connecting the DC power cable, cover the connectors with a rubber vulcanizing tape as shown below, to prevent water seeping into the transceiver.

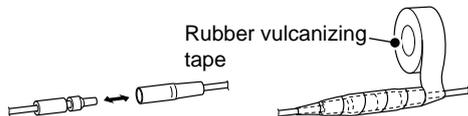

Antenna

A key element in the performance of any communication system is an antenna. Ask your dealer about antennas and the best place to mount them.

Fuse replacement

One fuse is installed in the supplied DC power cable. If a fuse blows or the transceiver stops functioning, track down the source of the problem, if possible, and replace the damaged fuse with a new, rated one.

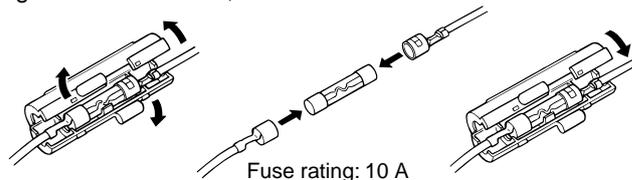

■ Supplied accessories

The following accessories are supplied.

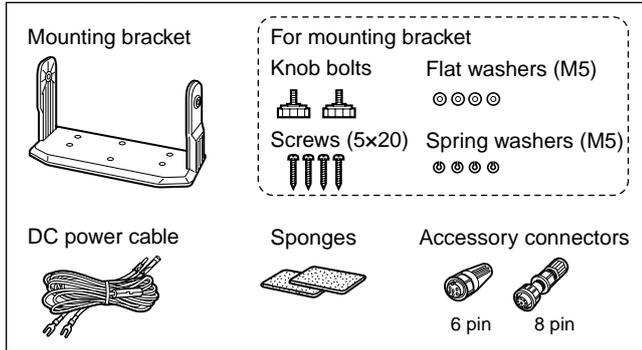

◇ Accessory connectors set up

The accessory connectors are used for the accessory cable connection to the connectors **5** and **6** as at left.

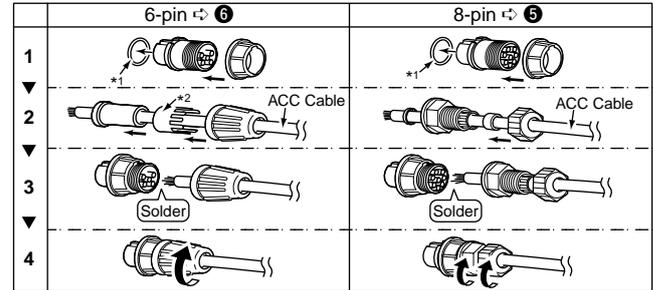

*1 Be sure to set these rings to keep the waterproof capability.

*2 Select either larger or smaller one to suit to the cable diameter.

■ Power supply connections

CAUTION: IC-GM651 should be connected to the DC power supply through the PS-250 DC-DC POWER SUPPLY, sold by the set with the IC-GM651, when it is operated.

Before connecting the DC power cable, make sure the power is OFF, and the DC power cable polarity is correct.

- Red : positive + terminal
- Black : negative – terminal

BE SURE to connect the supplied DC power cable only, and **DO NOT** extend the cable length.

The PS-250 DC-DC POWER SUPPLY, sold by the set with the IC-GM651, converts the input voltage (10.8 to 31.2 V DC) from the DC power supply, then provides 12.5 V DC, 5.3 A of the continuous power to the transceiver.

The optional PS-240 AC-DC POWER SUPPLY converts the input voltage (85.0 to 264.0 V AC; 47 to 63 Hz) from the AC outlet, then provides 14.5 V DC, 7 A of the continuous power to the PS-250.

◇ Connecting to the DC power supply through the PS-250

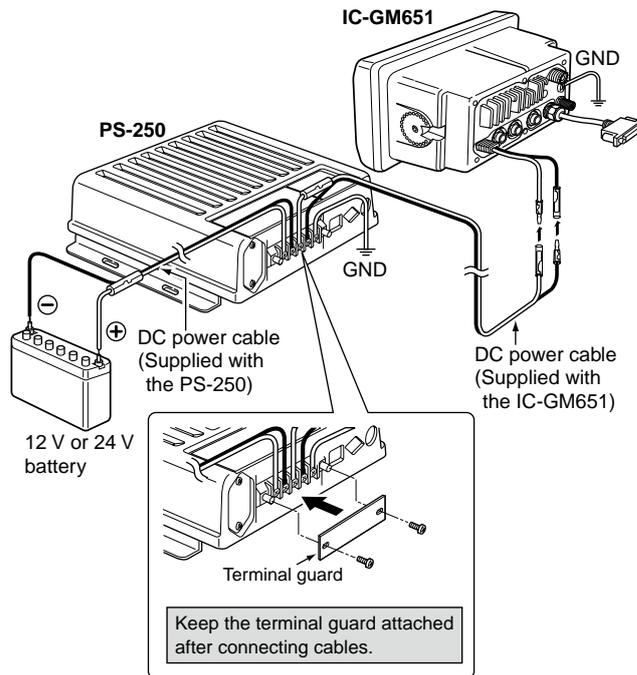

◇ Connecting to the AC outlet through the PS-250 and optional PS-240

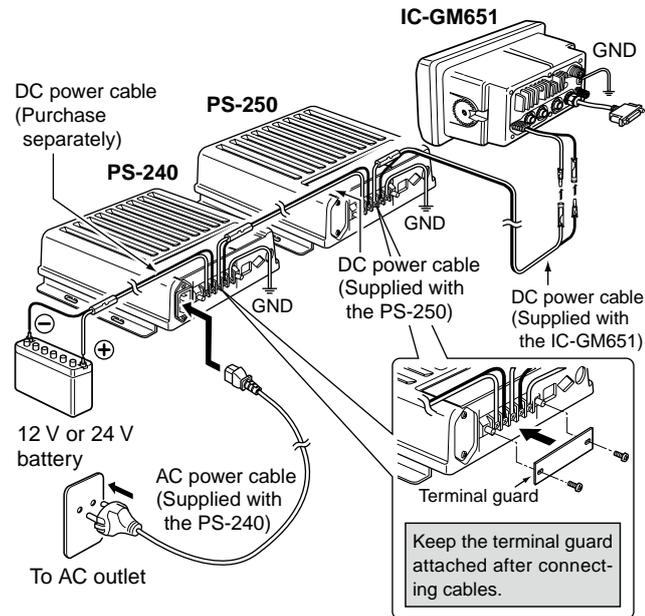

CAUTION: NEVER short the DC power terminals of the PS-250/PS-240 when connecting a DC power cable. Otherwise there is danger of electric shock and/or equipment damage.

When AC voltage is stopped applying, the PS-240 switches to the DC operation, then AC voltage is applied again, it switches back to AC operation automatically.

■ Mounting the transceiver

◇ Using the supplied mounting bracket

The universal mounting bracket supplied with your transceiver allows overhead or onboard mounting.

- Mount the transceiver securely with the 4 supplied screws (M5 × 20) to a surface which is more than 10 mm thick and can support more than 5 kg.
- Mount the transceiver so that the face of the transceiver is at 90° to your line of sight when operating it.

CAUTION: KEEP the transceiver and microphone at least 1 meter away from your vessel's magnetic navigation compass.

NOTE:

- Check the installation angle; the function display may not be easy-to-read at some angles.
- When mounting the transceiver on the place that is prone to strong vibration, use the supplied sponges between the transceiver and mounting bracket for reducing the effect of the vibration.

• OVERHEAD MOUNTING

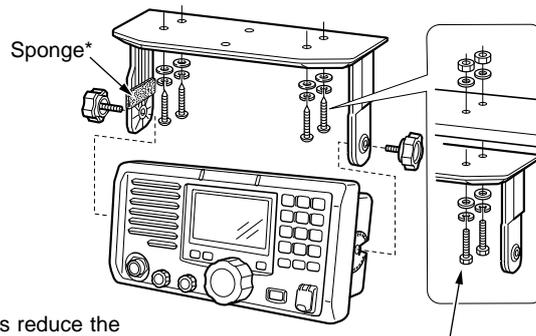

*Sponges reduce the vibration effects. See NOTE at left.

These screws are shown a mounting example only. Not supplied with accessories.

• MOUNTING ON THE BOARD

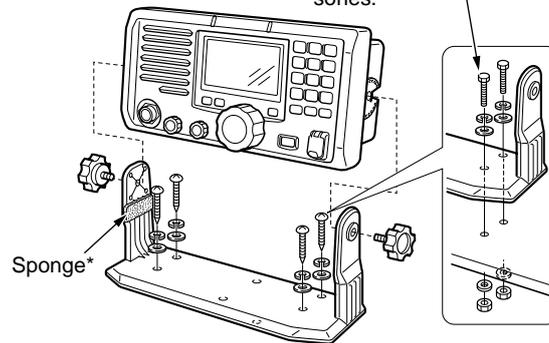

■ MB-75 installation

An optional MB-75 FLUSH MOUNT KIT is available for mounting the transceiver to a flat surface such as an instrument panel.

CAUTION: KEEP the transceiver and microphone at least 1 meter away from your vessel's magnetic navigation compass.

- ① Using the attached template, carefully cut a hole into the instrument panel (or wherever you plan to mount the transceiver).
- ② Slide the transceiver through the hole as shown below.

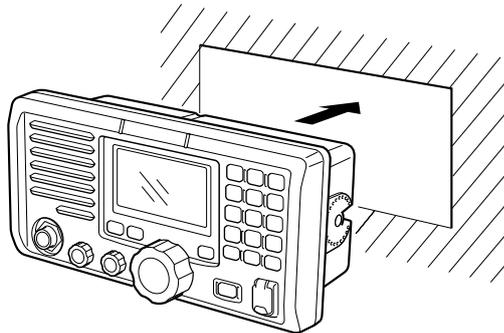

- ③ Attach the 2 supplied bolts (M5 × 8 mm) on either side of the IC-GM651.

- ④ Attach the clamps on either side of the IC-GM651.
 - Make sure that the clamps align parallel to the IC-GM651's body.

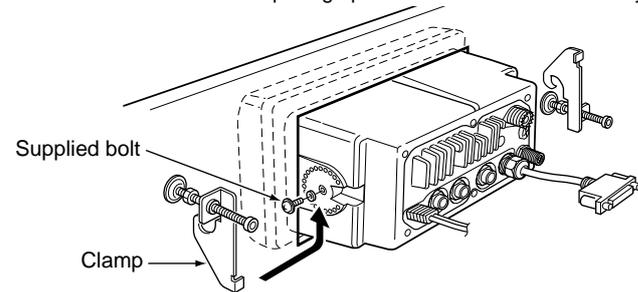

- ⑤ Tighten the end bolts on the clamps (rotate clockwise) so that the clamps press firmly against the inside of the instrument control panel.
- ⑥ Tighten the locking nuts (rotate counterclockwise) so that the IC-GM651 is securely mounted in position as below.

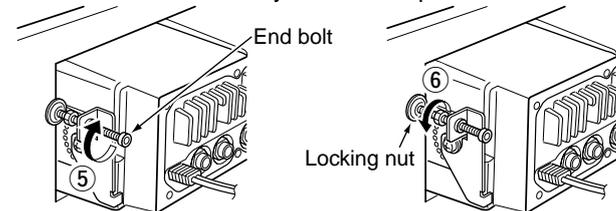

- ⑦ Connect the antenna and power cable, then return the instrument control panel to its original place.

■ Microphone (HM-126RB)

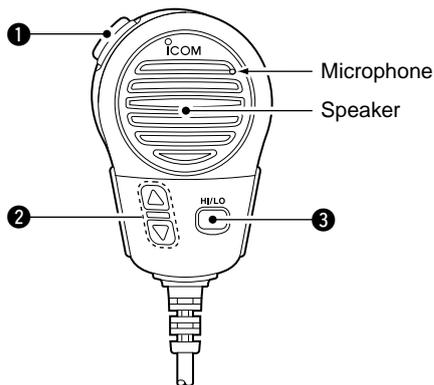

① PTT SWITCH [PTT]

Push and hold to transmit; release to receive. (p. 9)

② CHANNEL UP/DOWN KEYS [▲]/[▼]

- Push either key to change the operating channels, Set mode settings, etc. (pgs. 7, 8, 104)
- Checks TAG channels, changes scanning direction or resumes the scan manually during scan. (p. 16)

③ TRANSMIT POWER KEY [HI/LO]

- Push to toggle the power high and low. (p. 8)
 - Some channels are set to low power only.
- While pushing and holding [HI/LO], turn power ON to toggle the microphone lock function ON and OFF. (p. 12)

◇ Connection

Insert the connector cable into the mic connector ([MIC]) on the front panel, and tighten the cable nut as shown below.

⚠ **CAUTION: NEVER** connect the optional handset (HS-98) here.

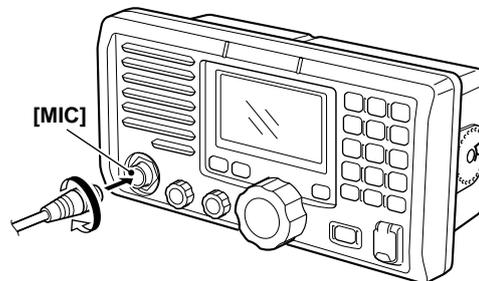

■ Handset (HS-98)

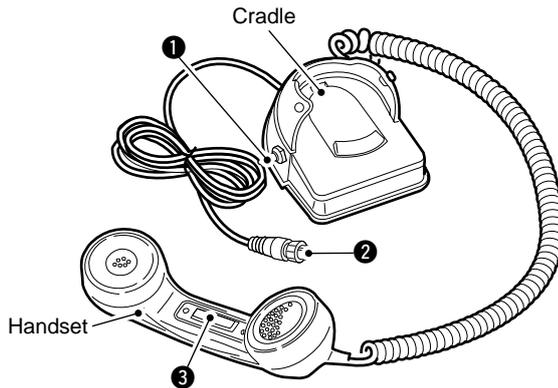

① SPEAKER SWITCH

Toggle the connected external speaker output ON and OFF when pick the handset up.

• **When the switch is set to “” position**

- Emits the receiving audio from the connected external speaker.

• **When the switch is set to “” position**

- Mutes the connected external speaker output.

• The receiving audio can be heard from the earpiece of the handset.

- Replace the handset into the cradle to emits the receiving audio from the connected external speaker.

② HANDSET CONNECTOR

Insert the connector cable into the handset connector ([HAND SET]) on the rear panel, and tighten the cable nut as shown below.

③ PTT SWITCH [PTT]

Push and hold to transmit; release to receive.

◇ Connection

Insert the connector cable into the handset connector ([HAND SET]) on the rear panel, and tighten the cable nut as shown below.

CAUTION: NEVER connect the optional hand microphone (HM-126RB) here.

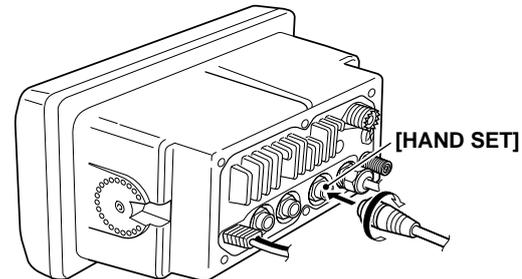

9

TROUBLESHOOTING

PROBLEM	POSSIBLE CAUSE	SOLUTION	REF.
The transceiver does not turn ON.	<ul style="list-style-type: none"> • Bad connection to the power supply. 	<ul style="list-style-type: none"> • Check the connection to the transceiver. 	pgs. 109, 110, 112
No sound from speaker.	<ul style="list-style-type: none"> • Squelch level is too high. • Volume level is too low. • Speaker has been exposed to water. • Internal speaker is turned OFF. 	<ul style="list-style-type: none"> • Set [SQL] to the threshold point. • Set [VOL] to a suitable level. • Drain water from the speaker. • Turn the internal speaker ON in Set mode. 	p. 8 p. 8 p. 13 p. 107
Transmitting is impossible, or high power can not be selected.	<ul style="list-style-type: none"> • Some channels are programmed for low power or receive only in regulations. • The output power is set to low. 	<ul style="list-style-type: none"> • Change channels. • Push [H/L] to select high power. 	pgs. 7, 8, 121 p. 8
Scan does not start.	<ul style="list-style-type: none"> • TAG channel is not programmed. 	<ul style="list-style-type: none"> • Set the desired channels as TAG channels. 	p. 16
No beeps.	<ul style="list-style-type: none"> • Beep tones are turned OFF. • The squelch is open. 	<ul style="list-style-type: none"> • Turn the beep tone ON in Set mode. • Set [SQL] to the threshold point. 	p. 107 p. 8
Distress call cannot be transmitted.	<ul style="list-style-type: none"> • MMSI (DSC self ID) code is not programmed. 	<ul style="list-style-type: none"> • Program the MMSI (DSC self ID) code. 	p. 18

■ Specifications

◇ General

- Frequency coverage : TX 156.000–161.450 MHz
RX 156.000–163.425 MHz
- Mode : FM (16K0G3E), DSC (16K0G2B)
- Current drain (at 24 V) : TX high (25 W) 3.5 A
Max. audio 1 A
- Power supply requirement : 12/24 V DC (10.8 to 31.2 V)
- Frequency stability : ±5 ppm
- Operating temp. range : –15°C to +55°C
- Antenna impedance : 50 Ω nominal
- Input impedance (Hand mic) : 2 kΩ
- Output impedance (audio) : 4 Ω
- VDR interface
 - Impedance : Ballanced 600 Ω
 - Ground : Floating
 - Audio level : TX –4 dBm (typical)
(at 1 kHz, ±3 kHz deviation)
 - RX –3 dBm (typical)
(at 1 kHz, ±3 kHz deviation)
- Dimensions (Projections not included)
 - IC-GM651 : 220(W) × 110(H) × 109.4(D) mm
 - PS-250 : 250(W) × 67(H) × 200(D) mm
- Weight
 - IC-GM651 : Approx. 1600 g
 - PS-250 : Approx. 2100 g

◇ Transmitter

- RF output power : 25 W and 1 W
- Modulation system : Variable reactance frequency modulation
- Max. frequency deviation : ±5.0 kHz
- Spurious emissions : Less than 0.25 μW
- Adjacent channel power : More than 70 dB
- Audio harmonic distortion : Less than 10%
(at 1 kHz, 60% deviation)
- Residual modulation : More than 40 dB
- Audio frequency response : +1 to –3 dB of 6 dB/octave
range from 300 Hz to 3000 Hz

◇ Receiver

- Receive system : Double conversion superheterodyne
- Sensitivity (20 dB SINAD) : –5 dBμ emf (typical)
–5 dBμ emf (typical) (CH 70 receiver)
- Squelch sensitivity : Less than –2 dBμ emf
- Spurious response : More than 73 dB
- Intermodulation : More than 75 dB
- Adjacent channel selectivity : More than 75 dB
- Hum and noise : More than 45 dB
- Audio output power : 2.0 W at 10% distortion with a 4 Ω
load

* This specification is described when the IC-GM651 is used with the PS-250.

All stated specifications are subject to change without notice or obligation.

10 SPECIFICATIONS AND OPTIONS

◇ Dimensions

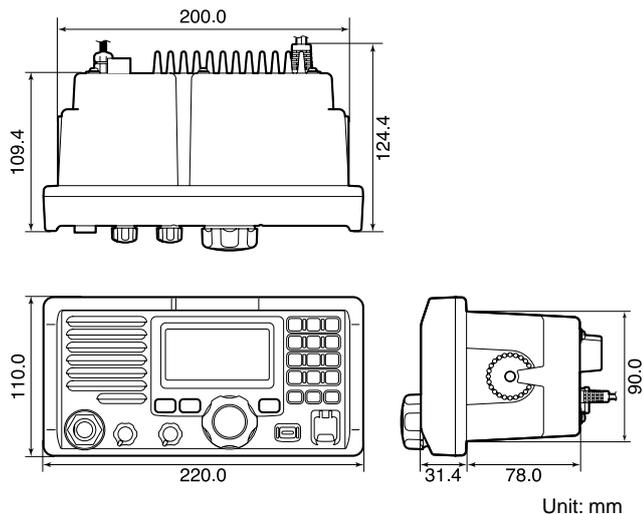

■ Options

- **PS-240** AC-DC POWER SUPPLY
Provides stable 14.5 V DC output converted from 85 to 264 V AC power source.
- **HS-98** HANDSET
Provides clear audio reception during offshore conditions and comes in handy for listening privacy on board.
- **HM-126RB** HAND MICROPHONE
Equipped with [▲]/[▼] (channel up/down,) [HI/LO], [PTT], speaker and microphone.
- **MB-75** FLUSH MOUNT KIT
For mounting the transceiver to a panel.

CHANNEL LIST 11

• International channels

CH	Frequency (MHz)		CH	Frequency (MHz)		CH	Frequency (MHz)		CH	Frequency (MHz)		CH	Frequency (MHz)		CH	Frequency (MHz)	
	Transmit	Receive		Transmit	Receive		Transmit	Receive		Transmit	Receive		Transmit	Receive		Transmit	Receive
01	156.050	160.650	11	156.550	156.550	21	157.050	161.650	62	156.125	160.725	72	156.625	156.625	82	157.125	161.725
02	156.100	160.700	12	156.600	156.600	22	157.100	161.700	63	156.175	160.775	73	156.675	156.675	83	157.175	161.775
03	156.150	160.750	13	156.650	156.650	23	157.150	161.750	64	156.225	160.825	74	156.725	156.725	84	157.225	161.825
04	156.200	160.800	14	156.700	156.700	24	157.200	161.800	65	156.275	160.875	75 ^{*3}	156.775	156.775	85	157.275	161.875
05	156.250	160.850	15 ^{*2}	156.750	156.750	25	157.250	161.850	66	156.325	160.925	76 ^{*3}	156.825	156.825	86	157.325	161.925
06	156.300	156.300	16	156.800	156.800	26	157.300	161.900	67	156.375	156.375	77	156.875	156.875	87	157.375	157.375
07	156.350	160.950	17 ^{*2}	156.850	156.850	27	157.350	161.950	68	156.425	156.425	78	156.925	161.525	88	157.425	157.425
08	156.400	156.400	18	156.900	161.500	28	157.400	162.000	69	156.475	156.475	79	156.975	161.575			
09	156.450	156.450	19	156.950	161.550	60	156.025	160.625	70 ^{*1}	156.525	156.525	80	157.025	161.625			
10	156.500	156.500	20	157.000	161.600	61	156.075	160.675	71	156.575	156.575	81	157.075	161.675			

*1 DSC operation only.

*2 Channels 15 and 17 may also be used for on-board communications provided the effective radiated power does not exceed 1 W, and subject to the national regulations of the administration concerned when these channels are used in its territorial waters.

*3 1 W only.

The use of these channels should be restricted to navigation-related communications only and all precautions should be taken to avoid harmful interference to channel 16, e.g. by limiting the output power to 1 W or by means of geographical separation.

Count on us!

A-6630H-1EX
Printed in Japan
© 2008 Icom Inc.

Printed on recycled paper with soy ink.

Icom Inc.
1-1-32 Kamiminami, Hirano-ku, Osaka 547-0003, Japan